

ATCO

Retailer Guide

• **A Retailer's Handbook for Distribution Access Service** •

Issued: April 27, 2022

The content of this manual is furnished for informational use only, and is subject to change without notice. While every precaution has been taken in the preparation of this reference manual, ATCO Gas and Pipelines Ltd. assumes no liability for errors or omissions, or damages resulting from the use of or reliance upon the information contained herein.

Table of Contents

CHAPTER 1 INTRODUCTION	4
CHAPTER 2 CONTACT INFORMATION	5
CHAPTER 3 ALBERTA'S NATURAL GAS MARKETPLACE	6
3.1 Overview	6
3.2 References and Readings	7
CHAPTER 4 TERMINOLOGY AND DEFINITIONS.....	8
CHAPTER 5 PREPARING FOR DISTRIBUTION ACCESS SERVICE	16
5.1 Meet Alberta Government Requirements	17
5.2 Provide Participant Information to ATCO Gas	17
5.3 Perform Compliance Testing Protocol	20
5.4 Set up Retailer Service	20
5.5 Begin Distribution Access Service	20
5.6 Requirements for Retailer Changes.....	20
CHAPTER 6 RETAILER SERVICE ACCOUNTS	21
6.1 AG's Systems for Retailer Service	21
6.2 Retailer Service Accounts.....	23
6.3 Account Balancing and Monitoring	24
6.5 Imbalance Purchase/Sale.....	31
6.6 Distribution Load Balancing.....	32
CHAPTER 7 KEY BUSINESS PROCESSES	33
7.1 Communications.....	33
7.2 Select Retailer Request (Enrollment).....	33
7.3 Update Customer Information (UCI).....	34
7.4 Request Update to Customer Information (RUC)	34
7.5 Connecting a New (never-been-metered) Site	34
7.6 Energize Request (ENR).....	35
7.7 De-Energize Request (DER).....	36

7.8	Request Off-Cycle Meter Read (ROR).....	38
7.9	De-Select Request (DSR)	38
7.10	Revoke De-Select Request (RDS).....	38
7.11	Revoke De-energize Request (RDR)	38
7.12	Site Cycle Changes (SCC).....	39
7.13	Site Profile Characteristics (SPC)	39
7.14	Site IDs.....	39
7.15	Meter Accuracy Dispute	39
7.16	Request Settlement Data.....	40
7.17	Request Usage History from Company	40
CHAPTER 8 PRUDENTIAL REQUIREMENT POLICIES.....		41
8.1	Initial Credit Information	41
8.2	Setting of Prudential Requirements.....	41
8.3	Financial Obligations.....	41
8.4	Drawing-on Security	41
8.5	Interest Paid on Security	42
8.6	Confidentiality	42
CHAPTER 9 DISTRIBUTION BILLING AND PAYMENT.....		42
9.1	Tariff Billing File (TBF)	42
CHAPTER 10 COMPLIANCE TESTING PROTOCOL.....		43
10.1	Introduction.....	43
10.2	Compliance Testing & Certification	43
10.3	Testing Support	43
10.4	Prerequisites	43
10.5	Compliance Tests	44
10.6	Process Rejections.....	45
CHAPTER 11 LOAD SETTLEMENT.....		46
APPENDIX A QUALIFICATION CHECKLIST.....		53
APPENDIX C PREAUTHORIZED PAYMENT AGREEMENT.....		56

APPENDIX D ELECTRONIC FUNDS TRANSFER AGREEMENT 59

APPENDIX E REPRESENTATION AND WARRANT AGREEMENT 62

APPENDIX F AUTHORIZATION AND RELEASE FORM 64

APPENDIX G LETTER OF CREDIT 65

APPENDIX H GUARANTEE..... 67

APPENDIX I CONFIDENTIALITY AGREEMENT 72

APPENDIX J AGENCY APPOINTMENT AGREEMENT..... 73

Chapter 1 Introduction

This Guide was developed by ATCO Gas (AG) to be used by Retailers, the Default Supply Provider (DSP) and Self-Retailers who have entered into a Retail Service Agreement with the Company for Distribution Access Service in accordance with the Gas Utilities Act and the Regulations made thereunder. This Guide also applies to any party who will be acting as an Agent on behalf of the Retailer(s), the DSP, or Self-Retailer(s) for transactions including, but not limited to, retail billing and load settlement.

This Guide is intended to provide an overview of AG's business processes in order to effectively deal with the Company in its service area. Understanding the procedures described in this Guide will allow for better interaction with AG and benefit all customers purchasing their natural gas requirements from Retailers, DSPs, or for Self-Retailers (or their Agents) who choose to purchase natural gas services for their own use.

This Guide serves as a companion to the Company's *Retailer Terms and Conditions for Gas Distribution Service*, which defines the relationship between the Company as an Owner, and Retailers, the DSP, Self-Retailers and Agents. The Company's Terms and Conditions and this Guide can be accessed at AG's website at gas.atco.com.

AG is committed to following the practices outlined in this Guide in order to provide a consistent framework for dealing with Retailers/DSP, Self-Retailers and Agents. However, as these practices will likely not cover every situation that arises, it may be necessary to deviate from the Guide in certain circumstances. The Company reserves the right to modify this Guide from time to time and without notice to reflect changes to the gas utility industry or the changing needs of industry participants.

While every effort is made to accurately reflect ATCO Gas' Retailer Service in this Guide, in the event of conflict then the provisions of *Rule 028 Natural Gas Settlement System Code*, *Rule 004 Alberta Tariff Billing Code*, *ATCO Gas Retailer Terms and Conditions for Gas Distribution Service*, *ATCO Gas Customer Terms and Conditions for Gas Distribution Service*, and *ATCO Gas Rate Schedules* shall prevail.

Chapter 2 Contact Information

Contact information is subject to change without notice. Please refer to ATCO Gas' website at www.atco.com for more recent information.

2.1 Published telephone numbers for customers/retailers

Customer Assistance Centre

Monday to Friday, 7 am to 7 pm,
except holidays

Alberta (toll-free in Alberta) 310-5678

Email: naturalgas@atco.com

Chat: <http://www.atco.com/>

SMS: 28261

24-hour Natural Gas Emergency Lines

Edmonton and local calling areas 780-
420-5585

Calgary and local calling areas 403-245-
7222

All other areas in Alberta (toll-free in
Alberta) 1-800-511-3447

2.2 Retailer and Agent Services, Transactions and Billing

Email: RetailerContact@atcogas.com

Phone: 310-5678

2.3 Retailer Service Accounts, Nominations and Account Balancing

Gas Coordinators, Gas Management

Email: GasCoordination@atco.com

Phone: 780-420-7199

Chapter 3 Alberta's Natural Gas Marketplace

3.1 Overview

A brief overview of the roles and responsibilities of the various players in key segments of the industry follows.

Transmission

Utilities, including ATCO GAS, used to include high-pressure lines (transmission facilities) across the province. Some of these facilities are now owned and operated by a division of the Company called ATCO Pipelines. Following integration on October 1st, 2011, NOVA Gas Transmission Ltd. (NGTL) and ATCO Pipelines operate under one rate and service structure in Alberta, with NGTL holding all customer contracts within the Alberta System.

Distribution

ATCO GAS (AG), as a *Pipe Services Provider and Pipe Owner* for Customers in its service area, is responsible for the reliable and safe delivery of natural gas to end-use Customers. AG enables Retailers and the DSP to have access to its gas distribution system so Retailers and the DSP can sell natural gas directly to Customers. AG develops delivery rates for the use of the system, manages the operations and maintenance of the distribution system, and connects/disconnects sites at Retailer or DSP request.

For more information on the services that distributors provide Customers, refer to *Roles, Relationships and Responsibilities Regulation, A.R. 186/2003* and other applicable regulations developed by Alberta Energy, which can be accessed at www.alberta.ca.

Energy

In the competitive natural gas marketplace, end-use Customers buy natural gas from Retailers or the DSP, or can carry out Retailer functions to obtain gas services for their own use. Energy is delivered to end-use Customers in AG's service area via AG's gas distribution system. Retailers compete for Customers and ensure they have the appropriate arrangements with Customers necessary to provide energy service. It is the Retailer's or DSP's responsibility to purchase natural gas from the producers and to arrange delivery of gas to its Customers. As mentioned above, Customers who choose to self-retail can also purchase gas from the producers for their own use.

Retailers, the DSP, Self-Retailers and any other parties, such as Agents, carrying out Retailer/DSP transactions with the Company will first be required to fulfill a number of requirements to the satisfaction of AG before the Company will provide Distribution Access Service to the Retailer, the DSP, Self-Retailer, or Agent. These requirements are discussed in subsequent chapters and can also be found in the Company's Terms and Conditions for Distribution Access Service.

Agents

A Retailer, the DSP, or Self-Retailer who chooses not to perform some or all of the Retailer/DSP transactions with the Company may make an arrangement to have a third-party act as its Agent to perform functions such as retail billing and load settlement. Agents must ensure they have made the appropriate contractual arrangements to recognize this unique business relationship and meet any applicable regulations and guidelines.

3.2 References and Readings

All Retailers, DSPs, Self-Retailers and Agents providing service in the Company's service area should develop an understanding of the Alberta natural gas marketplace. Suggested references and readings are provided below that will give all parties a comprehensive overview of competitive choice in the province and information on the Company's current delivery rates.

- (a) **ATCO Gas Delivery Rates**  www.atco.com
 - Current Delivery Rates
 - Retailer Terms and Conditions for Gas Distribution Service
 - Customer Terms and Conditions for Gas Distribution Service

- (b) **Service Line Installation**

The process ATCO Gas follows for new service line and facility applications can be found at www.atco.com.

- (c) **Government Legislation and Regulations**
 - Gas Utilities Act*
 - Rural Utilities Act*
 - Gas Utilities Statutes Amendment Act*
 - Roles, Relationships and Responsibilities Regulation*
 - Default Gas Supply Regulation*
 - Code of Conduct Regulation*
 - Natural Gas Billing Regulation*
 - Other applicable regulations (final or draft form)

 <https://www.alberta.ca/>

- (d) **Rules under the Alberta Utilities Commission**
 - Rule 004 Alberta Tariff Billing Code*
 - Rule 028 Natural Gas Settlement System Code*

 <http://www.auc.ab.ca>

- (e) **Fair Trading Act**

 <http://www.qp.gov.ab.ca/documents/acts/F02.CFM>

- (f) **Marketing of Gas and/or Electricity Business License**

 <http://servicealberta.ca>

- (e) **Natural Gas Services in Alberta**
: <http://www.ucahelps.gov.ab.ca>
- (f) **VLTrader™**
<https://www.cleo.com/products/secure-data-integration/cleo-vltrader/>
- (g) **Digital Certificates**
 www.versign.com

Chapter 4 Terminology and Definitions

To assist the reader in understanding this Guide definitions of terminology used within are given below. AG's *Retailer Terms and Conditions for Gas Distribution Service* and Rule 028 and Rule 004 provide further definitions related to Retailer Service. In the event that the definitions in this Guide conflict with the definitions in the other documents, the definitions in the other documents shall prevail.

"Account" means a record maintained by ATCO Gas which contains receipts, deliveries, Rider D, Imbalance Purchase and Imbalance Sale, and adjustments applicable to each Retailer/DSP providing Gas Services to Customers.

"Account on the Transmission System" means the account held by the Company on NOVA Gas Transmission Ltd.

"Account Balancing" means the process of managing Gas receipts and/or deliveries in an Account in order to keep the difference, net of adjustments, within the tolerance specified by the Imbalance Window.

"Agent" means a person who performs functions on behalf of a Self-Retailer, Retailer, or DSP, including, but not limited to, retailer transactions with the Company.

"Rule 004" means Rule 004 Alberta Tariff Billing Code that contains the standards for communicating site-specific distribution and transmission charges and usage information.

"AMR" means automated meter reading.

"AG account transfer" means an ATCO Gas (AG) account transfer that is a transfer of gas supply between one Retailer Service account in AG's IRIS and another Retailer Service account in AG's IRIS as depicted in Chapter 6 of this Guide.

"AG-OP account transfer or OP Transfer" means an ATCO Gas – Other Pipeline Transfer and it is a transfer of gas supply to/from a Retailer/DSP account in AG's IRIS from/to an account on TC Energy's Customer Express and is implemented via AG's Account on the Transmission System as depicted in Chapter 6 of this Guide.

"AG or ATCO Gas or Company" means ATCO Gas, an operating division of ATCO Gas and Pipelines Ltd. or its successor that operates the gas distribution system.

"AP or ATCO Pipelines" means ATCO Pipelines, an operating division of ATCO Gas and Pipelines Ltd. or its successor that operates its footprint within the Alberta gas transmission system.

"AUC" means the Alberta Utilities Commission established under the *Alberta Utilities Commission Act, S.A. 2007, c.A-37.2*, as amended from time to time.

"Backcast or B1" means an estimate from DFSS of a Retailer/DSP's aggregate and per site consumption near the end of the gas day using models, actual and forecast temperatures and/or AMR.

"Balance Zone" see *"Imbalance Window."*

"Business Day" means a day other than Saturday, Sunday or a statutory or non-statutory holiday in the Province of Alberta during which financial banking privileges in Alberta are suspended.

"Company" means ATCO Gas, an operating division of ATCO Gas and Pipelines Ltd. or its successor.

"Connection" means the first time a new service is connected to the distribution system.

"CSV" means comma separated values.

"Customer" means a person, firm, partnership, corporation, organization or association (including without limitation, individual members of any unincorporated entity) who consumes gas in end-use at its location and is connected to AG's distribution system.

"Customer Class" means the main usage type of each site. Each site is grouped into one of the following classes: Residential, Commercial, Apartment, Industrial, or Irrigation.

"Customer Terms and Conditions for Gas Distribution Service" means a document that outlines the terms of service to facilitate a service connection to the Company's gas distribution system.

"Day" means a period of twenty-four (24) consecutive hours.

"Day Type" refers to one of three DFSS classified day type values: weekday, weekend, or holiday. The use of day type as a variable depends on profile class.

"DCM" means Daily Cumulative Meter Transaction as found in Rule 028.

"DFSS" means the Daily Forecasting and Settlement System developed by AG for the purpose of calculating Forecast and Backcast gas consumption and Settlement gas consumption for each Retailer or the DSP.

"DSP" means the Default Supply Provider that is a gas distributor, or a person authorized by a gas distributor, that provides gas services to Customers under rates, tolls or charges, and terms or conditions approved by the AUC. ATCO Gas has authorized Direct Energy Regulated Services (DERS) to be its DSP.

"Digital Certificate" means an electronic signature used to establish a secure electronic connection for communication purposes.

"*Distribution Access Service or DAS*" means the AG service and/or AG's Retailer Terms and Conditions for that service that must be accepted by Retailers or the DSP in order to provide Gas Services to Customers connected to the gas distribution system.

"*Distribution Access Service Agreement*" means an agreement for the provision of Distribution Access Service pursuant to the Retailer Terms and Conditions for Gas Distribution Service, between the Company and a Retailer or the DSP in the form attached as Schedule A to the Retailer Terms and Conditions for Gas Distribution Service.

"*Gas Distribution Service Connections*" means the AG service and/or AG's Customer Terms and Conditions governing the relationship between AG and Customers, as well as between AG and any Retailer, the DSP, or another person the Customer has assigned to act on their behalf, which requires a service connection on the AG distribution system.

"*Distribution Tariff*" means a distribution tariff prepared by the Company in accordance with the Distribution Tariff Regulation, A.R. 162/2003, as amended from time to time.

"*Distribution Zone*" as defined in Rule 028 means all sites within an area defined by the load settlement agent.

"*Electronic Funds Transfer Agreement (EFT)*" means an agreement to transfer money for the purpose of payment by secure electronic means;

"*Final Monthly Settlement or S3*" means the third and final calculation of load settlement for the settlement month that is performed by the 15th business day of the fourth month following the settlement month as described in Rule 028.

"*Forecast 1 or F1*" is the first estimate from DFSS of a Retailer/DSP's aggregate load for a gas day based on forecast temperatures.

"*Forecast 2 or F2*" is the second estimate from DFSS of a Retailer/DSP's aggregate load for a gas day based on forecast temperatures.

"*Forecast 3 or F3*" is the third estimate from DFSS of a Retailer/DSP's aggregate load for a gas day based on forecast temperatures.

"*Gas Day*" means a Day beginning at eight hours (08:00) Mountain Standard Time.

"*Gas Distribution Service*" means the service required to transport Gas to Customers by means of a Gas Pipeline System and includes any services the Gas Distributor is required to provide by the AUC or is required to provide under the *Act* or Regulations made thereunder.

"*Gas Distributor*" means the owner, operator, manager or lessee of a gas distribution system as defined in the *Gas Utilities Act*.

"*Gas Pipeline System*" means all those facilities owned or used by the Company in the receipt, delivery, transportation, measurement and testing of Gas, (including, without limitation, transmission and distribution lines, regulators, meters, equipment and machinery).

"*Gas Services*" as defined in the *Gas Utilities Act* means:

- i. the Gas that is provided and delivered, and

- ii. the services associated with the provision and delivery of the Gas, including:
 - a. arranging for the exchange or purchase of the Gas,
 - b. making financial arrangements to manage the financial risk associated with the price of Gas,
 - c. arranging for Gas Distribution Service,
 - d. arranging for delivery of Gas to the gas distributor's specified Point(s) of Receipt,
 - e. storage,
 - f. billing, collection and responding to customer billing inquiries,
 - g. maintaining information systems, and
 - h. any other services specified by the Minister by order as Gas Services.

"Gas Settlement" means any or all of Initial Monthly Settlement, Interim Monthly Settlement and/or Final Monthly Settlement as defined in the Natural Gas Settlement System Code.

"GJ" means gigajoules or one billion (1 000 000 000) joules.

"High Use" means a site that uses more than 8000 GJ annually.

"Imbalance" means the difference between energy quantities of Gas received, and Gas delivered, net of adjustments, in an Account each Gas Day. Imbalance is described in greater detail in Chapter 6.

"Imbalance Window" means a range of Imbalances within which an account is considered to be in balance without action being taken to adjust receipts into or deliveries from that Account.

"Imbalance Reporting Information System (IRIS)" is the system ATCO Gas developed for the creation of accounts for Retailers and the DSP to record gas supply receipts and deliveries as well as monitor their accounts.

"Imbalance Purchase/Sale" means the removal from, by Imbalance Purchase, or addition to, by Imbalance Sale the daily Account Imbalance energy quantity outside the nearest Account daily Imbalance Window boundary, as the case may be, in a Retailer/DSP Account by ATCO Gas which will be settled financially.

"Initial Monthly Settlement or S1" means the first calculation of load settlement for the settlement month that is performed by the 5th business day of the month immediately following the settlement month as described in the Natural Gas Settlement System Code.

"Intercontinental Exchange or ICE" means Intercontinental Exchange, Inc., an electronic trading platform that may be used by market participants for transactions related to, among others, natural gas energy purchase or sale.

"Interim Monthly Settlement or S2" means the second calculation of load settlement for the settlement month that is performed by the 15th business day of the second month following the settlement month as described in the Natural Gas Settlement System Code.

"Load" means the amount of natural Gas delivered or required to be delivered at any specific point or points in the Gas Pipeline System.

"Load Balancing" is the process of managing receipts in order to meet the consumption requirements of a Customer served from the Gas Pipeline System and includes daily balancing by ATCO Gas of its Account on the Transmission System.

"Load Balancing Deferral Account or LBDA" refers to the AG account that records the revenues and expenses associated with load balancing the Gas Pipeline System, including without limitation carrying charges, credit support charges, gas purchases from Gas Co-ops, un-metered gas light service revenue and hit lines revenue.

"Load Profile" means a series of load or consumption amounts for each interval over a particular time period.

"Low Use" means a site that uses less than 1,200 GJ annually.

"Mid Use" means a site that uses more than 1,200 GJ and less than 8,000 GJ annually.

"Meter Data Manager (MDM)" means the entity responsible for collecting meter data, correcting and validating meter data, storing historical data, and reporting load and consumption data and times to appropriate parties;

"Minimum Energy Imbalance Window" means the ± 500 GJ/d for accounts where the daily delivery is equal to or less than 5,000 GJ/d and ± 1000 GJ/d for accounts where the daily delivery is greater than 5,000 GJ/d. The minimum imbalance window works in concert with the *Imbalance Window Percentage* as the minimum is to be used if the imbalance window percentage ($\pm 5\%$) results in a lesser daily imbalance tolerance than the minimum.

"Month" means a period beginning at eight hours (08:00), Mountain Standard Time, on the first day of a calendar month and ending at eight hours (08:00), Mountain Standard Time, on the first day of the next succeeding calendar month.

"Natural Gas or NG Settlement System Code or NGSSC" means Rule 028 - the document governing the standards for determining and communicating retail natural gas consumption for the purpose of load settlement as well as required transactions related to site ownership, changes in service, and customer information.

"Nomination" means a request in electronic or other written or verbal form for Gas to flow at a Point of Receipt, a Point of Delivery, or for receipt into or delivery out of an Account at a specified quantity on a specified date(s).

"NOVA Gas Transmission Ltd. or NGTL" means NOVA Gas Transmission Limited, a wholly owned pipeline of TC Energy Corporation. or its successor that operates the gas transmission system in Alberta.

"Pipe Services Provider (PSP)" means an entity that owns and operates the gas distribution system.

"Point of Delivery" for service by the Company to the Customer means the outlet side of a meter unless otherwise specified in a Natural Gas Service Agreement.

"Point of Receipt" means the point on the Company's system at which a Retailer/DSP delivers Gas to the Gas Pipeline System under the Distribution Access Service Agreement. For clarity, this is usually indicated by the Company's acceptance of receipt of a Nomination into the Retailer/DSP Account.

"Preauthorized Payment Agreement (Authorization)" means an agreement between the Company and Retailer or Self-Retailer to allow for automatic withdrawal of payments from the Retailer's account.

"Profile" means a series of load or consumption amounts for each interval over a particular time period.

"Profile Class" means the intersection of customer class and usage type of the site.

"Rate Schedule" means the natural gas rate schedule prepared by the Company and approved by the Alberta Utilities Commission, as amended from time to time.

"Reconnection" means when service is restored after physical de-energizing for any reason.

"Retail Service Agreement" means an agreement for the provision of Distribution Access Service pursuant to the Retailer Terms and Conditions for Gas Distribution Service, between the Company and a Retailer, or Self-Retailer.

"Retailer" means a person who sells or provides retail gas services directly to Customers and who is entitled to enroll Customers for Distribution Access Service under the Company's Retailer Terms and Conditions for Gas Distribution Service, and includes Self-Retailers and Agents acting on behalf of Retailers.

"Retailer Business Function Identification" means the two character identification that describes the Retailer's/DSP business function as a Retailer or a DSP as is specified in Rule 028.

"Retailer/DSP Account" means an Account held by a Retailer or the DSP.

"Retailer Identification or Retailer ID" means the nine-digit number that uniquely represents each Retailer/DSP operating within Alberta. The Canada Customs and Revenue Agency business number will be used as the Retailer Identification or as amended.

"Retailer of Record" means the Retailer or DSP who is listed in the Company's records through the procedures outlined in Rule 028 as well as the Retailer Terms and Conditions for Gas Distribution Service, and thereby recognized by the Company, as a particular Customer's Retailer or DSP for a Point of Delivery at a particular time.

"Retailer Service Account" is the record of retailer/DSP gas supply and consumption, including the specific components further described in Section 6.3.

"Retailer Terms and Conditions for Gas Distribution Service" means a document developed to enable Retailers to acquire access to the Company's gas distribution system for the purpose of allowing them to sell directly to end-use Customers.

"Rider D" means a rate rider, expressed as a percentage, approved by the AUC applicable to Retailer/DSP Accounts for the recovery in kind of Unaccounted For Gas.

"RRR or R3 Regulation" means the Roles, Relationships and Responsibilities Regulation, A.R. 186/2003 as amended from time to time.

"Rule 004" means the AUC's Rule 004: Alberta Tariff Billing Code, an operational document that defines the business processes and mechanics of how timely and accurate tariff bill-ready information is to be produced and transmitted to retailers by electricity and natural gas distributors for distribution and system access service in Alberta.

"Rule 028" means the AUC's Rule 028: Natural Gas Settlement System Code, an operational document that defines the business processes and mechanics of how natural gas settlement is to be carried out within the retail natural gas market in Alberta.

"Same Day or SD Nomination" means a Nomination occurring during a calendar Day for transactions applicable to the Gas Day commencing on the same calendar Day. ATCO Gas will accept SD Nominations for processing as depicted in Section 6.

"Self-Retailer" means a person carrying out Retailer functions to obtain gas solely for its own use.

"Service Connection" shall have the meaning ascribed thereto in Company's Customer Terms and Conditions for Gas Distribution Service.

"Settlement Month" Settlement month is the calendar month to which the Initial, Interim and Final Month Settlement relate.

"Settlement Period" means the number of months following the Settlement month during which one or more Gas Settlements will be performed.

"Site" means a unique end-use Point of Delivery, being the finest level at which settlement recognizes Retailer and DSP assignments and receives consumption data.

"Site Identification Number or Site ID" means a unique 13-digit identification number assigned by the Company for each unique end-use Point of Delivery.

"Tariff Bill File" means a physical, electronic file containing site-specific tariff charges, usage and demand information for given tariff bill periods; it may also contain applicable site-specific one-time charges as specified in Rule 004.

Tariff Bill Invoice" means an aggregated invoice that contains distribution tariff changes and may also contain Imbalance Purchase/Sale and Gas Settlement charges.

"Retailer Terms and Conditions for Gas Distribution Service" means a document developed to enable Retailers to acquire access to the Company's gas distribution system for the purpose of allowing them to sell directly to end-use Customers.

"Customer Terms and Conditions for Gas Distribution Service" means a document developed that outlines the terms of service to facilitate a service connection to the Company's gas distribution system.

“Title Transfer or NIT” means a transfer between customer accounts on TC Energy’s Customer Express. *“TC Energy’s Customer Express”* is NGTL’s system for all customers to monitor and balance their Account on the Transmission System.

“Transmission System” means all those facilities owned or operated by AP and NGTL in the receipt, delivery, transportation, measurement and testing of Gas (including, without limitation, transmission lines, regulators, meters, equipment and machinery).

“Ultra High Use” means a site that uses more than 100,000 GJs annually. *“Unaccounted for Gas or UFG”* is the difference between total system receipt and total system consumption and in this guide specifically refers to the Retailer and DSP share of Company’s unaccounted for Gas, as specified in rate Rider D of the Company’s Rate Schedule.

“Usage Type” refers to the level of annual gas usage for a site. There are four primary usage types: Ultra High Use, High Use, Mid Use, and Low Use.

“VLTrader™” means a software product adopted in the province for the purpose of securely transferring the standard files as defined herein.

“Weather Zone” means a geographic area around a weather station. Each site is assigned to one of the six weather stations (Edmonton, Grande Prairie, Fort McMurray, Red Deer, Calgary and Lethbridge) based on geographic location.

“Yesterday or YD Nomination” means a Nomination occurring during a calendar Day for transactions applicable to the Gas Day commencing on the previous calendar Day. ATCO Gas will accept YD Nominations for processing as depicted in Section 6.

Chapter 5 Preparing for Distribution Access Service

This chapter provides an overview and description of the initial steps necessary from a Retailer's/DSP's perspective to prepare and qualify for Distribution Access Service for service to customers in the ATCO Gas service area. Some of these qualification requirements may also apply to Self-Retailers and Agents. Contact ATCO Gas for more information. A brief description of each step is provided in this section.

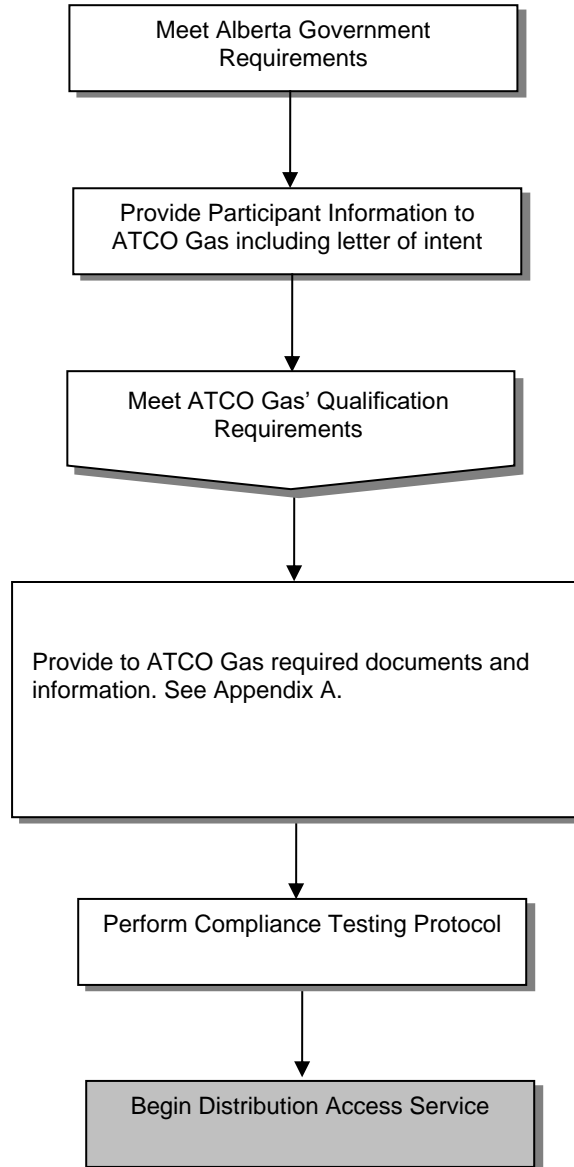

5.1 Meet Alberta Government Requirements

Retailers intending to operate in Alberta must meet the requirements established by Service Alberta under the ***Natural Gas Marketing Regulation (Licensing of Retailers)*** enacted under the *Fair Trading Act*.

This regulation specifies the requirements for Retailer licensing, the form of contracts between Retailers and Customers, a Retailer code of conduct, and a disclosure statement. ATCO Gas will request the party to warrant in writing that it will comply with the provisions of the *Fair Trading Act*. If the Company determines that the party it is dealing with fails to comply with this Act, it will suspend further Distribution Access Service.

For more information, see: www.servicealberta.gov.ab.ca

5.2 Provide Participant Information to ATCO Gas

AG requires the following specific information from Retailers, DSPs, Self-Retailers and Agents who will be conducting business in the Company's service area:

- company name and address;
- Name, telephone number and email address of the representative who will act as the IRIS account administrator (see [Section 6.3 Retailer Service Accounts](#) of this Guide);
- Any other information requested by AG

5.2.1 Certified Copy of License

Under the Fair Trading Act (FTA), [Service Alberta](#) is responsible for licensing administration. Retailers and DSPs selling to residential and other consumers who will be using less than 2,500 GJ of natural gas annually are required to license with Service Alberta and to provide a certified copy of its license to AG. All Retailers and DSPs must comply with the provisions of the Fair Trading Act.

5.2.2 Distribution Access Service Agreement

This Agreement is required before a Retailer/DSP or Self-Retailer can provide service to customers or receive service for their own use. The Distribution Access Service Agreement establishes the contractual relationship between AG and the Retailer/DSP or Self-Retailer. The party that will deal directly with the Company for Distribution Access Service must sign this Agreement. The Company will not deal with more than one party for a Point of Service at any given time. Only one signed Agreement is required for each party regardless of the number of customers it serves in the Company's service area.

The Distribution Access Service Agreement can be found in the [ATCO Gas Retailer Terms and Conditions for Gas Distribution Service](#).

5.2.3 Retailer of Record and Credit Application (Appendix B)

Any party entering into a Distribution Access Service Agreement must complete this part of the application and submit it to AG for review. The Application is to be completed by the party requesting access service.

This application is used by AG to compile specific information about the Retailer/DSP/Self-Retailer. The credit information section of the application form is used by the Company to establish the applicant's initial prudential security requirement.

The Company will conduct its evaluation based on the prudential requirements established in Article 11 of the Retailer Terms and Conditions for Gas Distribution Service. A more detailed description of the Company's prudential policy can be found in Chapter 8 of this Guide.

All information provided by the party in relation to its financial standing and designated by the party as confidential will be treated under the Confidentiality Agreement between the Company and the party. This Agreement is set out in Appendix J of this Guide.

Forms are to be completed as outlined and forwarded to ATCO Gas by email or fax. A new form must be submitted by the Retailer/DSP whenever there are any changes to company information included on the form.

5.2.4 Electronic Payment Agreements (Appendix C or D)

AG prefers electronic payment services for electronically billed Retailers, the DSP or Self-Retailers.

AG has established two electronic billing options for Retailers, the DSP and Self-Retailers electing to send and receive payments electronically. The Preauthorized Payment Agreement and the Electronic Funds Transfer Agreement can be found in Appendix C and Appendix D, respectively. These agreements set forth the terms and conditions for making payments and providing remittance information electronically. The Retailer, DSP or Self-Retailer must advise the Company which method of payment it wishes to enter into so the Company can make the appropriate arrangements and provide the correct completed agreement.

5.2.5 Representation and Warrant Agreement (Appendix E)

The Representation and Warrant Agreement executed by a Retailer/DSP allows the Distributor to release historical consumption data to a Retailer through electronic transaction without individual customer consent documentation. Refer to AUC Rule 10 found on the AUC's website www.auc.ab.ca

This Agreement requires the use of VLTrader™

5.2.6 Authorization and Release form (Appendix F)

Retailers, the DSP, or agents of Retailers and the DSP who do not use VLTrader™ will be required to submit the signed Authorization and Release Form, providing individual customer consent to release of usage data. Article 13 in the ATCO Gas Retailer Terms and Conditions for Gas Distribution Service outlines the applicable fees for AG to provide historical usage data.

5.2.7 Letter of Credit (Appendix G)

A Retailer, the DSP or Self-Retailers are required to provide a letter of credit from a Canadian Chartered Bank.

5.2.8 Guarantee (Appendix H)

5.2.9 Confidentiality Agreement (Appendix I)

5.2.10 Agency Appointment Agreement (Appendix J)

A Retailer, the DSP or a Self-Retailer may enter into arrangements with a third party to act as its Agent to perform certain functions such as retail billing and load settlement. An Agency Appointment Agreement, as shown in Appendix K, was developed to set out the Terms and Conditions to permit the Company to interact with the Agent on behalf of the Retailer, the DSP or a Self-Retailer.

5.2.11 Warranted Letter

All Retailers, the DSP and Self-Retailers conducting business in the AG service area will be required to warrant in writing that they will:

- (a) Comply with the **Fair Trading Act**, which governs proper and fair business practices in Alberta and is enforced by Alberta Government Services.
- (b) Comply with Rule 004 Alberta Tariff Billing Code and **Rule 028 Natural Gas Settlement System Code**, which governs load settlement of the delivery and exchange of natural gas and the transactions between the Retailer/DSP and AG www.atco.com. Both Rules can be found on the AUC's website, www.auc.ab.ca. It is important to note that if an Agent is conducting transactions on behalf of a Retailer, the DSP or a Self-Retailer, it must also meet this requirement.

5.2.12 Qualification Checklist (Appendix A)

The qualification checklist outlines the process of qualification and some of the key areas that will require communication between representatives of the Retailer, the DSP, Self-Retailer or Agent, and the Company. Please note that reference should be made to the Retailer Terms and Conditions for Gas Distribution Service for the rules governing the application of these defined processes listed in the checklist.

5.3 Perform Compliance Testing Protocol

Any participant performing electronic transactions with the Company must be able to demonstrate that it can communicate electronically with the Company. The compliance testing protocol tests and evaluates compliance with Rule 028 and ensures that key electronic transactions such as enrollment and the updating of customer information meet all requirements. In preparation for service to customers, AG representatives will work with participants to ensure that all testing is satisfactory. Please note that compliance testing will not proceed until all required and signed documentation by both Retailer or the DSP and ATCO Gas is in place.

5.4 Set up Retailer Service

When a new Retailer, the DSP or a Self-Retailer meets AG requirements to provide gas services in AG's service area, AG will set up a Retailer Service Account.

5.5 Begin Distribution Access Service

Upon completion of this process, Retailers, the DSP and Self-Retailers may begin enrollment of sites. The Company will continually monitor all participants to ensure it meets its obligations under the Retailer Terms and Conditions for Gas Distribution Service and its Retail Service Agreement. This includes evaluating on an ongoing basis the Retailer's, DSP's or Self-Retailer's credit and prudential requirements.

5.6 Requirements for Retailer Changes

From time to time, ATCO Gas is contacted by a retailer who already has retailer service and advises that the nature of the retailer's business has changed and to request direction on how this change is handled.

Below are the requirements of ATCO Gas, based on the nature of the retailer's request.

1) Retailer name change for existing Retailer ID

- The request is for a simple name change on an existing Retailer ID. There is no organizational change that will affect the Retailer's prudential requirements.
- ATCO Gas is able to accommodate the request by coordinating internal communications to update the Retailer name in its systems related to billing, transactions and retailer service.
- The retailer must submit a written letter stating this is a name change and there are no other organizational changes that would affect the Retailer's prudential requirements with ATCO Gas. A copy of the Corporate Registry change is required. The effective date of the name change is required.
- ATCO Gas requires a minimum of 30 days to make this change.
- ATCO Gas will notify the Retailer in writing when the change has been made.

ATCO Gas reserves the right, upon reviewing the Retailer's supplied documentation, to determine if additional security is required or if the process related to becoming a new retailer must be followed.

2) Additional Retailer ID is required for existing Retailer having access service

A request from a retailer already having access service to create a new retailer ID will be require an amendment to Schedule A of the Distribution Access Service Agreement and the Representation and Warrant Agreement.

Chapter 6 Retailer Service Accounts

This chapter provides an overview of Retailer Service accounts. Retailer Service accounts show the supply/consumption balance between a Retailer's or the DSP's gas supply and the aggregate consumption of its customers.

6.1 AG's Systems for Retailer Service

The systems that support the delivery of AG's Retailer Service are shown in the diagram below. A summary of the purpose of these systems is as follows:

- **DGIS:** The Distribution Gas Information System receives gas sample information, including heat value and provides it to CIS; DGIS also performs gas analysis and odorant monitoring.
- **WMS:** The Work Management System is used to collect raw meter reading data which is then provided to CIS.
- **CIS:** The Customer Information System is a data records system for customer information provided by Retailers/DSPs, Retailer requests through VLTrader, and gas consumption records and history¹ also used for ATCO Gas billing. CIS also provides site energy consumption through a system interface with the DFSS.
- **DFSS:** The Daily Forecasting and Settlement System provides site-level consumption for Backcast and Settlement to Retailers/DSP and aggregate Forecast, Backcast, and Settlement consumption to Retailers/DSPs and, through a system interface with IRIS, to the Retailer Service Accounts.
- **VLTrader™:** The software used to communicate between AG and Retailers or DSP using the file structures specified in Rule 028 and Rule 004.
- **IRIS:** The Imbalance Reporting Information System contains Retailer Service accounts and is used by Retailers, the DSP and AG to monitor the daily balance between gas supply and customer consumption, to issue gas supply Nominations, and to administer Imbalance Purchase/Sales.

¹ EUB Decision 2001-75, Section 6.7, page 100.

- **IRIS Online:** The web-based interface used by Retailers and the DSP to access their accounts in IRIS to monitor the daily balance between gas supply and customer consumption and to issue gas supply Nominations.
- **TC Energy's Customer Express:** The NGTL system that contains AG's account on the Transmission System that sources gas supply for Retailer/DSP accounts based on Nominations in IRIS. Further information on NGTL's transmission service can be found at www.tcenergy.com

AG Retailer Service Systems

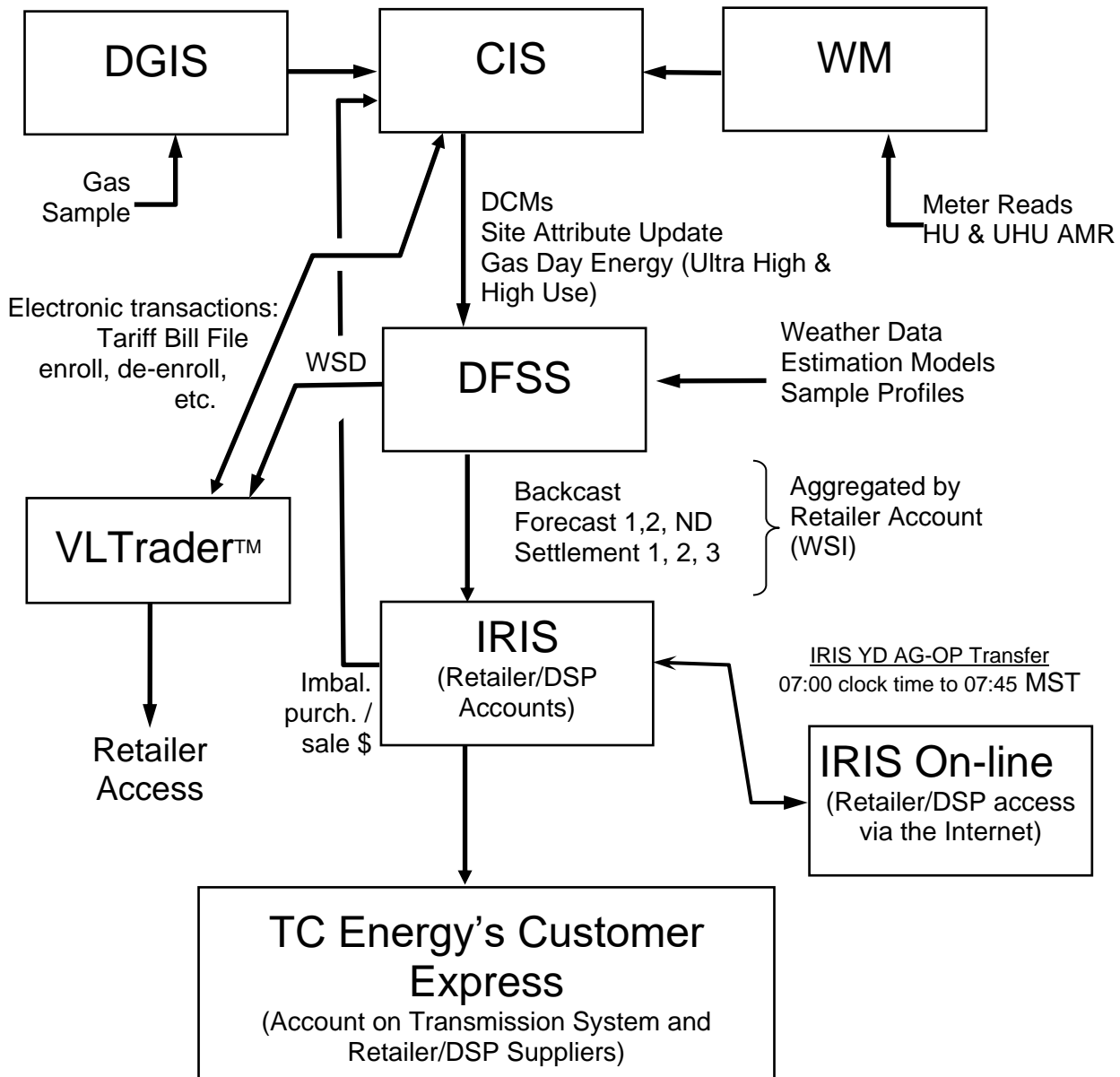

6.2 Retailer Service Accounts

Retailer Service Accounts on AG's distribution systems are administered in the context of the hierarchy of accounts within the Intra-Alberta pipeline system, as depicted in the figure below.

AG's gas distribution system has no directly connected gas production. Therefore, all gas supply received into Retailer Service Accounts on AG's systems must be supplied from accounts on NGTL's transmission system.

Hierarchy of Intra-Alberta Accounts

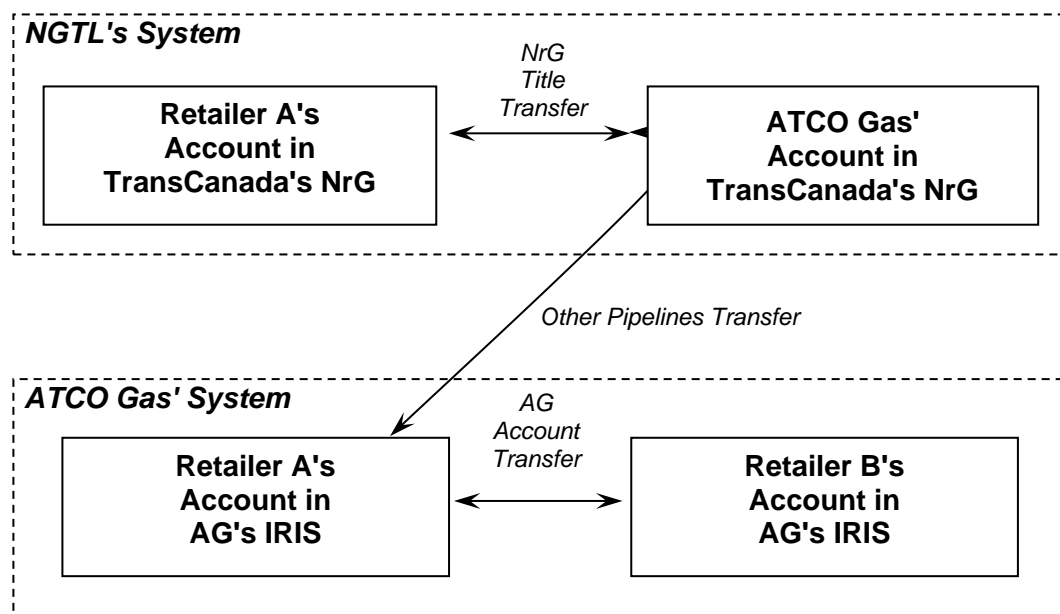

As noted earlier, the transfer of natural gas to Retailer Service Accounts from a Retailer/DSP account(s) on NGTL's system occurs by exchange through AG's Account on the Transmission System. The Retailer/DSP will originate an Other Pipelines Transfer Nomination(s) in its Retailer Service Account in AG's IRIS and AG will upload the Nomination into **TC Energy's** Customer Express. As shown in the diagram above, the Retailer/DSP's Other Pipelines Transfer Nomination will appear in **TC Energy's** Customer Express as a Title Transfer between the Retailer/DSP's account in NGTL's Customer Express and AG's Account on the Transmission System in NGTL's Customer Express.

The Retailer/DSP can obtain gas supply for its account in AG's IRIS from other IRIS Account holders using Account Transfers or in **TC Energy's** Customer Express from other NGTL account holders using Title Transfers.

New Retailer Service Accounts

When a new Retailer has met all conditions to become a retailer on its system, AG will set up a Retailer Service Account.

AG will also set up the Retailer's designated Account administrator and provide an IRIS user ID (email address) and password to that administrator. The Retailer's Account administrator is

then responsible for setting up other users authorized by the Retailer to access its Account(s) in IRIS.

Further information is available to authorized users in the IRIS Training Guide at <http://iris.atcogas.com>

6.3 Account Balancing and Monitoring

Gas service providers (Retailers and the DSP) are responsible for maintaining their Accounts in **daily balance** within the daily Imbalance Window specified in AG's Retailer Terms and Conditions for Gas Distribution Service. The Imbalance Window is a range of positive and negative Account Imbalances within which a Retailer Service Account is considered to be balanced. The purpose of the Imbalance Window is:

- to recognize that while the Backcast delivery is the best available estimate at the time, it will be different than the gas settlement delivery (i.e., there will be a settlement variance);
- to constrain the effect of Account Imbalances on the daily load balancing requirement of the gas distribution system as a whole and consequently to other customers.

AG's Retailer Terms and Conditions for Gas Distribution Service deal with Account Imbalances outside the window through Imbalance Purchase or Sale. The daily Imbalance Window for AG's gas distribution systems is:

- $\pm 5\%$ of the daily Backcast with a Minimum Energy Imbalance Window of:
 - ± 500 GJ when the daily Backcast is less than or equal to 5,000 GJ;
 - $\pm 1,000$ GJ when the daily Backcast is greater than 5,000 GJ up to 20,000 GJ.

In the event the Imbalance Window needs be increased or decreased the Company will change the Daily Imbalance Window percentage applicable to Retailer/DSP Accounts. Notification would be provided to Retailers by 12 hours (12:00) for changes effective the following Gas Day.

Imbalance Purchase/Sale for daily Energy amounts outside the daily imbalance window is described in further detail in Section 6..

AG's Retailer Terms and Conditions for Gas Distribution Service also describe the monitoring performed by AG of the Account balancing being performed by Account holders. If a Retailer does not provide any gas supply for its customers within a Gas Day and that action has not been authorized by AG, then AG will take action to balance that Account by Imbalance sale. If this condition persists, AG will de-enroll the Retailer's sites according to the procedure described in the Retailer Terms and Conditions for Gas Distribution Service Article 13.4. These Terms and Conditions can be found on AG's website at www.atco.com.

A flow chart demonstrating AG's account monitoring process logistics is given on the following pages.

Gas Day 1

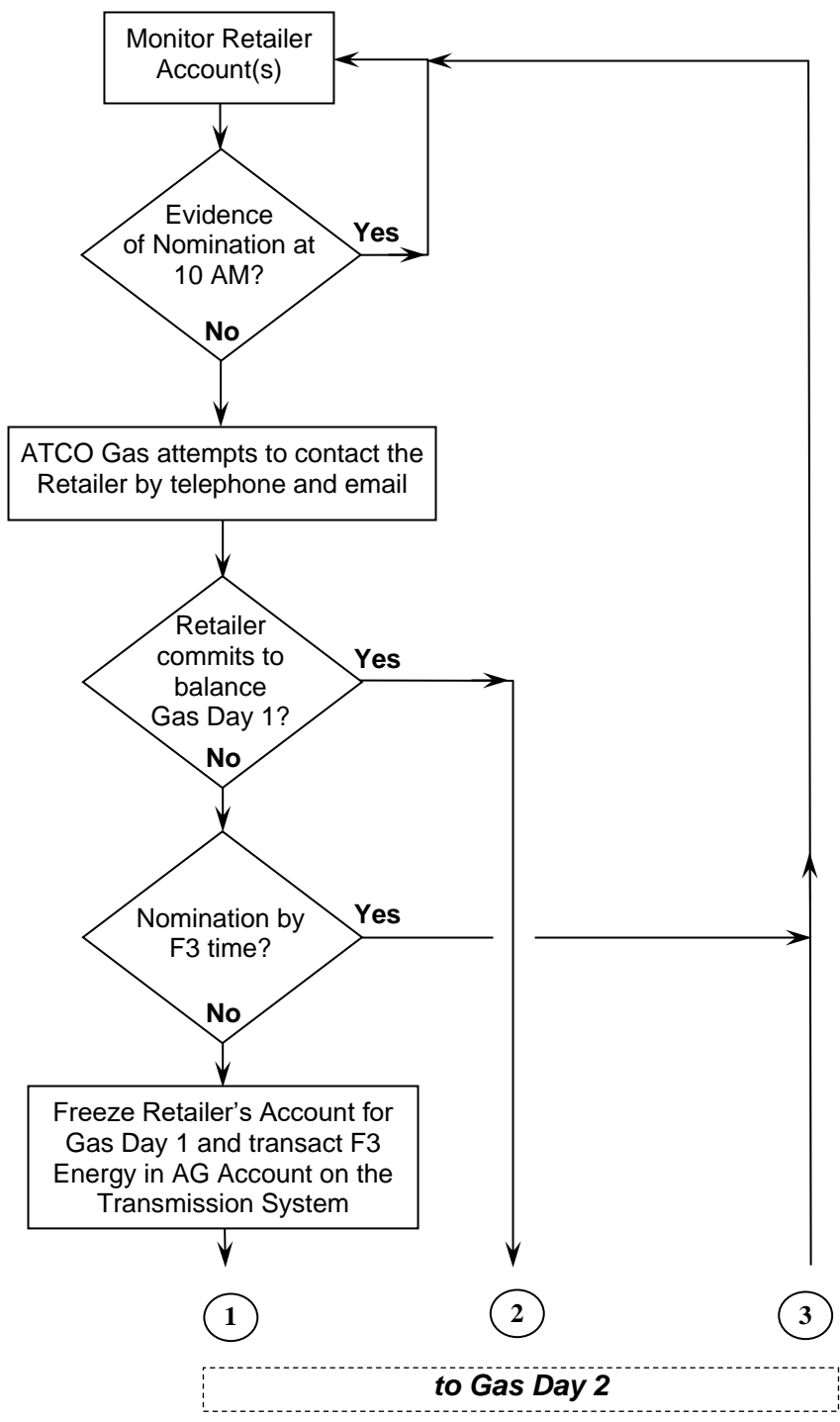

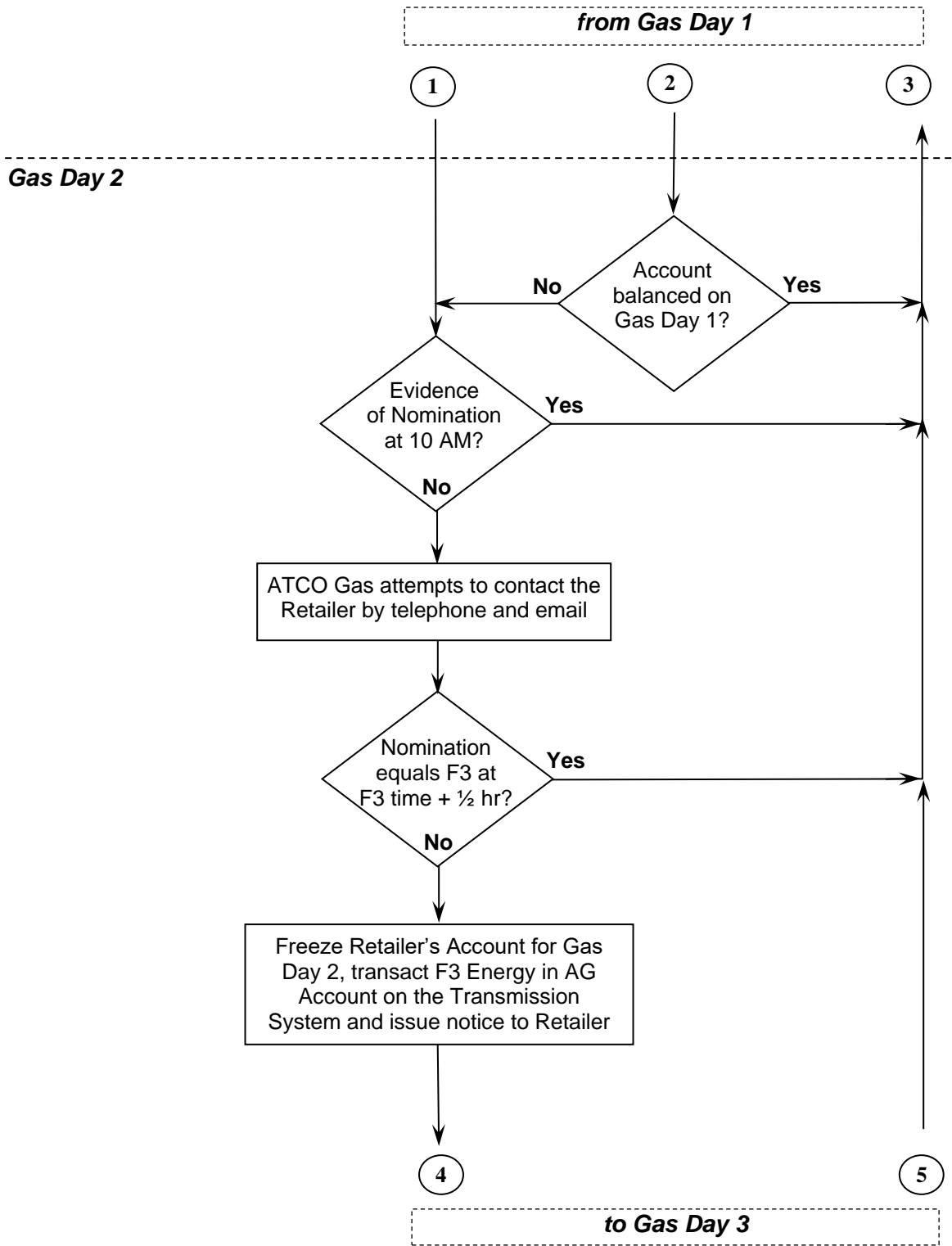

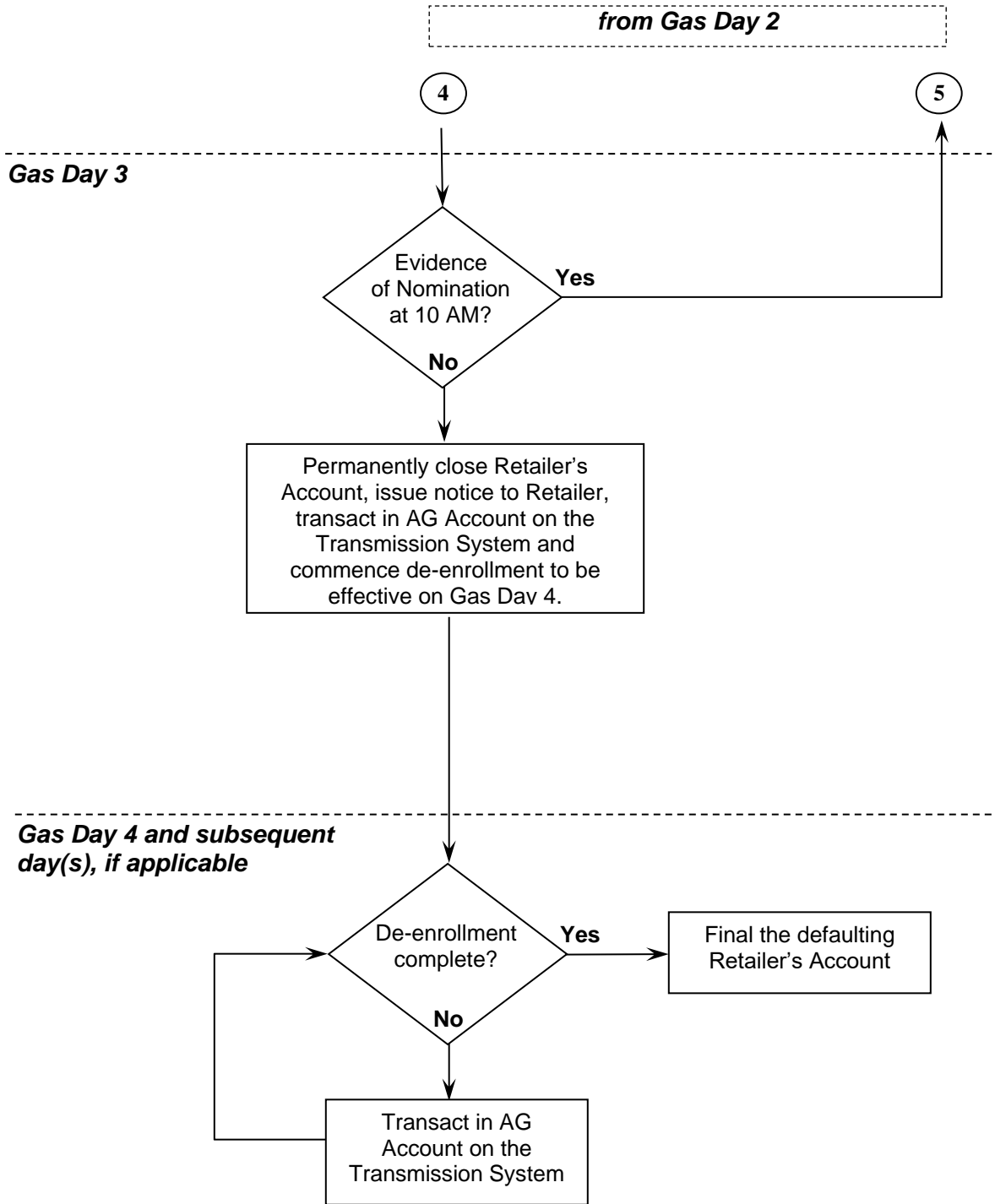

Retailer Service Account Components

Each Retailer Service Account in IRIS contains the components noted below with the imbalance determined each day using the following formula:

$$\text{Imbalance (GJ)} = \text{daily receipt (GJ)} - \text{daily delivery (GJ)} - \text{daily Rider D recovery (GJ)} - \text{daily imbalance purchase (GJ)} + \text{daily imbalance sale (GJ)} + \text{daily adjustment (GJ)}$$

Where:

- Rider D recovery means the recovery of unaccounted for gas which is calculated in IRIS as Rider D percent times the delivery
- Receipt means net gas supply Nominated in IRIS into the Retailer Service Account for that day;
- Delivery means the sum of consumption for all sites enrolled with the Retailer or DSP for that day. Total site consumption is provided from the DFSS to IRIS via a WSI file (see Rule 028 for information about the WSI file);
- Imbalance Purchases and Imbalance Sales mean the Energy amount outside the \pm Imbalance Window calculated in IRIS and removed from or added to the account respectively, rounded to the nearest GJ (Imbalance Purchase/Sales are described in greater detail in Section 6.);
- Adjustments mean any variance attributable to a previous period which is brought forward in IRIS into the current day and includes:
 - The previous day's closing account balance,
 - The daily allocation of the prior Month(s) UFG settlement variance
 - The daily allocation of any other appropriate Energy adjustment(s) when applicable to the Account.

Gas Settlement Variance

Prior Month(s) settlement variances are settled financially and included on the Tariff Bill Invoice (TBI) on the 15th working day or the first billing cycle following the 15th working day. The financial settlement will capture a price each day to be applied to the settlement amount. This will lead to either a debit or credit being displayed on the TBI each Month. The price that will be used is the NGX Daily Index price, also called the "ICE-NGX AB-NIT Same Day Index (2A)" or "AECO Daily Index".

Prior Month(s) UFG volumetric adjustments are included in the Account in the Month immediately following the month in which they were determined and are worked off equally each day with any required correction for rounding included in the last day of the month.

There are three variances applicable to Gas Settlement:

- B1-S1: The variance between the Initial Monthly Settlement and Backcast is determined in the first (1st) month following the settlement month and is included on the Tariff Bill Invoice on the 15th business day in the first (1st) month following the settlement Month;

- S1-S2: The variance between the Interim Monthly Settlement and Initial Monthly Settlement is determined in the second (2nd) Month following the settlement Month and is included on the Tariff Bill Invoice on the 15th business day in the second (2nd) Month following the settlement Month;
- S2-S3: The variance between the Final Monthly Settlement and Interim Monthly Settlement is determined in the fourth (4th) Month following the settlement Month and is included on the Tariff Bill Invoice on the 15th business day in the fourth (4th) Month following the settlement Month;

Further information on Gas Settlement is available in Rule 028.

6.4 Timelines for Retailer Service Accounts

Timelines for SD Nominations

The Nomination timelines for SD Nominations are:

- 08:00 to 20:00 MST each calendar day

Timelines for YD Nominations

The Nomination timelines applicable to YD Nominations used by Retailers and the DSP for balancing their Retailer Service Accounts are depicted in the diagram below.

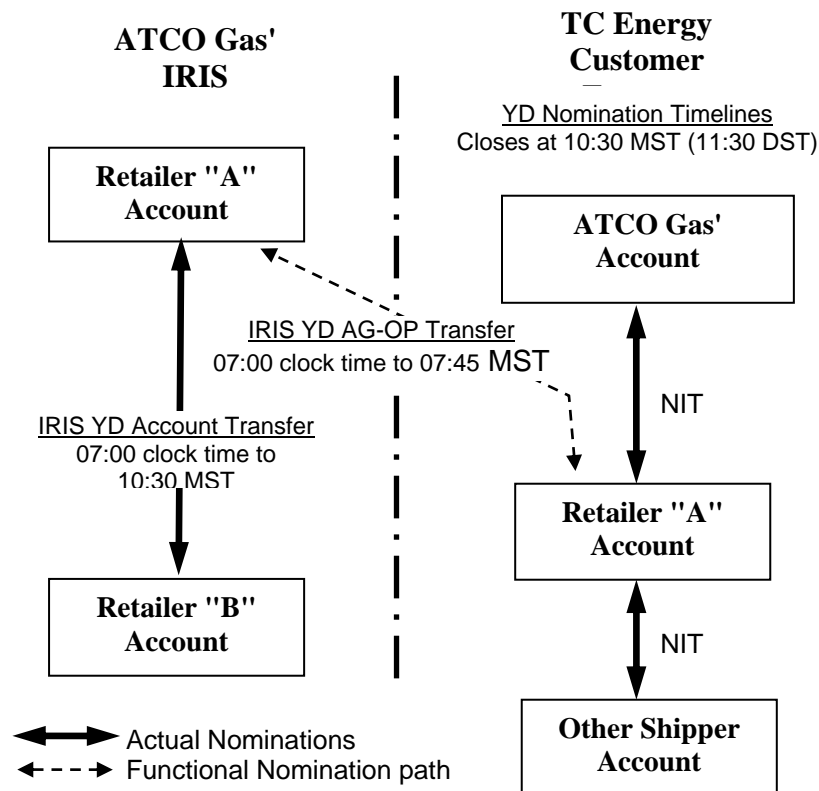

In summary, the YD balancing Nomination timelines for Retailer Service Accounts are as follows:

- YD Nominations for Gas Day 1 using IRIS AG-OP transfers will be accepted until 7:45 AM MST on calendar day 2;
- YD Nominations for Gas Day 1 using IRIS AG Account Transfers will be accepted until 10:30 AM MST on calendar day 2;

The YD balancing Nomination timelines for accounts on NGTL's systems are specified in their respective terms and conditions and/or business practices. Contact TC Energy for further information.

Timelines for Consumption Data

Total consumption will be reported in Retailer Service Accounts in IRIS at the times shown below.

Forecast 1 for *Gas Day 2* will be issued by **12:00 PM** on *calendar Day 1*

Forecast 2 for *Gas Day 2* will be issued by **07:00 AM** on *calendar Day 2*

Forecast 3 for *Gas Day 2* will be issued by **12:00 PM** on *calendar Day 2*

Backcast for *Gas Day 2* will be issued by **07:00 AM** on *calendar Day 3*

The Account Forecasts 1 to 3 inclusive are provided by AG for the information of Retailer Service account-holders. AG's Retailer Terms and Conditions do not require a Retailer Service account-holder to nominate gas supply using these consumptions if the account-holder believes it has better data.

However, AG's Retailer Terms and Conditions **DO** require the account holder to balance within the Imbalance Window when Backcast consumption is reported near the end of the Gas Day. If a Retailer Service Account is not balanced within the Imbalance Window by 10:30 AM MST, an Imbalance Purchase or Sale will be applied to the Account to bring the Imbalance to the nearest boundary of the Imbalance Window as described in Section 6. below.

6.5 Imbalance Purchase/Sale

As described in Section 6., the Imbalance Window is a range of positive and negative Account Imbalances within which a Retailer Service Account is considered to be balanced. If a Retailer Service account Imbalance is outside the Imbalance Window range at the end of the daily Account balancing timeline given in Section 6. then the Energy amount outside the Imbalance Window will automatically be deducted from or added to the Account.

When there is an excess of gas supply relative to consumption in the account for a Gas Day, the energy amount outside the positive Imbalance Window will be deducted from the account by Imbalance Purchase at the price specified in Schedule D of the Retailer Terms and Conditions for Gas Distribution Service.

When there is a deficiency of gas supply relative to consumption in the Account for a Gas Day, the Energy amount outside the negative Imbalance Window will be added to the account by Imbalance Sale at the price specified in Schedule D of the Retailer Terms and Conditions for Gas Distribution Service.

Daily Imbalances of Retailer Service Accounts affect the load balance of the gas distribution system as a whole. Accordingly, the contra-account for Imbalance Purchase/Sale is the Load Balancing Deferral Account. Distribution Load Balancing is described in further detail in Section 6. below.

6.6 Distribution Load Balancing

The R3 Regulation requires ATCO Gas, as the gas distributor, to perform load balancing for the gas distribution system. AG holds transmission transportation service under NGTL's Terms and Conditions on behalf of all AG distribution customers. AG holds an Account on the Transmission System represented in TC Energy's Customer Express.

ATCO Gas' distribution load balancing (Load Balancing) includes both traditional physical and administrative aspects of balancing ATCO Gas' Account on the Transmission System represented in TC Energy's Customer Express. This load balancing function does not, however, include providing gas supply to the end use customer, which is a responsibility of the Retailers/DSP. AG takes custody of each retailer's gas supply in its Account on the Transmission System.

ATCO Gas' distribution load balancing is about the adjustment of gas supply provided to NGTL's transmission system in response to the gas flows delivered to ATCO Gas' distribution system at interconnection stations. ATCO Gas' Account contains all of its distribution system gas supplies (receipts) and all of its distribution consumptions as evidenced at interconnection stations (deliveries).

As discussed in Section 6.4, each retailer and the DSP is responsible for providing AG with sufficient gas supply to satisfy the consumption of their distribution end-use customers within the Imbalance Window. This expectation is designed to minimize the effect of Account imbalances on the load balancing requirement. As discussed in Section 6.6 above, Imbalance Purchases/Sales mitigate the financial consequences of those Imbalances on load balancing.

AG's load balancing obligation is eased by the Retailer/DSP Account Balancing using the best available data.

AG's Transmission Account is subject to daily balancing requirements set by NGTL's Terms and Conditions. AG's daily load balancing requirement is the imbalance in its Account on the Transmission System outside the Balance Zone as defined in those Terms and Conditions. To do so, AG enters the Intra-Alberta Natural Gas Market via the Intercontinental Exchange (ICE) to perform purchase or sale transactions.

If AG's Account on the Transmission System is packed outside of the Balance Zone (i.e., cumulative imbalance is outside the positive range of the imbalance window), then AG must sell gas on the Intra-Alberta Market to bring the Account within tolerance. If AG's Account on the Transmission System is drafted outside of the Balance Zone (i.e., cumulative imbalance is outside the negative range of the imbalance window), then AG must buy gas on the Intra-Alberta Market to bring the Account within tolerance.

Chapter 7 Key Business Processes

Most Retailer/Distributor business events are initiated by the transactions found in Rule 028 and Rule 004. This chapter provides an overview of the communication methods required by AG in relation to these Rules.

7.1 Communications

In accordance with the Rules, all market participants are required to have and maintain VLTrader™ to communicate electronically for transaction-initiated procedures outlined in this chapter.

The following outlines some of the details required to communicate electronically via VLTrader™.

- (a) Microsoft Internet Explorer version 5.0 or higher with 128-bit encryption.
- (b) VLTrader™ certificate policy - Class 1 X.509 Digital Certificate(s)
- (c) All files sent to the participant will be 'Queued for Pickup' and will have to be retrieved manually using VLTrader™.
- (d) A participant cannot 'undo' sending a file, but can overwrite a file with a new version if resent on the same day. If the error cannot be corrected using this method, for example, the file is to be deleted and not replaced, the participant should contact ATCO Gas.
- (e) VLTrader™ will reject a file with a non-standard file name. Standard file names include those found within Rule 028 and Rule 004. Under this situation, the file will be routed to the Outbox, ready for the participant to retrieve. Error files will be marked with the letter 'R' at the end of the filename (please refer to section 10 for more information).
- (f) If a file contains any one record with an incorrect number of commas, the entire file is rejected.
- (g) Individual records within a file can be rejected for reasons that include but are not limited to wrong data types or oversized fields.
- (h) Participants must send separate files for each business transaction type.
- (i) The VLTrader™ mailboxes operate 24 hours a day.

7.2 Select Retailer Request (Enrollment)

Rule 028 Transaction - SRR

Select Retailer Request (SRR) describes the transaction used by Retailers/DSP to initiate Distribution Access Service. It enables the Retailer/DSP to begin serving its customers. Every SRR transaction must be accompanied by an associated Update Customer Information (UCI) transaction (see 7.3).

7.2.1 Electronic Enrollments

Rule 028 requires that all enrollments be accompanied by an Update Customer Information (UCI) transaction to ensure customer data is accurate. This customer data

must be accurate and current to ensure that AG may speak to individuals enrolled by the Retailer/DSP on matters related to distribution.

The Company will only deal with one Retailer/DSP at a Point of Service. A single Retailer must be designated to be the customer's Retailer when dealing with AG. Additional information may be found in Article 6 in the Retailer Terms and Conditions for Gas Distribution Service.

Should the Retailer/DSP submit an enrollment in error, Rule 028 describes the process to remedy. The Retailer or DSP shall notify the Company immediately through a De-select Retailer Request (DSR) transaction.

7.2.2 Enrollment Mechanics

Upon receipt of the SRR, the Company will validate the enrollment transaction, i.e., valid site ID, Retailer ID, settlement ID and that the required UCI transaction is received. ATCO Gas will process enrollments in accordance with Rule 028.

7.3 Update Customer Information (UCI)

It is important that AG has the most up-to-date customer information from the enrolled Retailer to be able to effectively and efficiently deal with situations that may affect the measurement of tariff billing for and delivery of natural gas to a customer's facility. In addition, the Company needs this information to fulfill its obligations to notify the Default Supply Provider (DSP) in the event a competitive Retailer de-selects the site for a reason other than "customer move."

The Company will notify the Retailer/DSP in the event a UCI transaction has failed by sending the same UCI with the suffix "R" and provide a transaction status code per process stated in Rule 028.

7.4 Request Update to Customer Information (RUC)

ATCO Gas may initiate a Request Customer Update (RUC) transaction to the enrolled Retailer/DSP where it is suspected the information provided in a UCI is incorrect or outdated. See Rule 028 for transaction details. Alternatively, AG will send an email to request

7.5 Connecting a New (never-been-metered) Site

Rule 028 transaction – SRR with UCI are the only requirements

This process describes the actions required to connect a new service location to the AG distribution system for the first time.

The Retailer or DSP enrolls a new service location through an SRR transaction and accompanying successful UCI.

AG schedules the meter installation (does not require Customer contact) when all of the following has occurred:

- Receipt of Retailer enrollment (SRR transaction and UCI), and
- Installation of the service line has been completed, and
- Receipt of permit from the municipality, initiated by the customer.

ENR orders issued by a Retailer/DSP for sites that have never been metered will fail for the reason of no infrastructure.

The Customer must make arrangements with a licensed contractor for the initial lighting of the natural gas appliances when the service is first connected. This is not a service provided by ATCO Gas.

Timing of Retailer's SRR – avoid post-dating account start date

Retailers and the DSP are encouraged to send their SRR transaction with UCI transaction as soon as possible after the customer applies for an Account. AG does not begin tariff billing to the Retailer or DSP until the meter has been installed and turned on.

Post-dating a customer's retailer Account start date delays AG's receipt of the enrollment. In these situations, the retailer's customer expects to have gas service on the day the Account starts. ATCO Gas, however, has just received the SRR and may not be able to schedule a meter installation for several weeks.

Before service is connected, the Company will apply the applicable rate schedule that is most favourable to the customer. This review is undertaken in accordance with Section 4.9 of the Company's Customer Terms and Conditions for Gas Distribution Service

7.6 Energize Request (ENR)

Rule 028 transaction

This process describes the actions required to reconnect and re-energize a customer's service connection to the Company's distribution system.

7.6.1 Work performed by AG

It is the Retailer/DSP's responsibility to inform the customer that the energization will be completed within three business days after receipt of the transaction and the amount of the current ATCO Gas reconnect fee (Schedule C of the Customer Terms and Conditions). ATCO Gas will not receive ENR transactions until the next business day.

An AG reconnect involves turning on service at the meter.

7.6.2. Retailer authorization

The requesting Retailer/DSP must be the enrolled Retailer before an energize request will be accepted by AG. An ENR transaction must be received from the retailer.

7.6.3 AG practices for scheduling reconnects

AG reconnect requests are scheduled for the first available business day within the three business days after the energize transaction has been received.

If the customer is willing to pay the higher same-day fee, the Retailer/DSP must warm transfer the customer to the ATCO Gas call centre. ATCO Gas will confirm with the customer whether same-day reconnect can be accommodated based on current demands for service. Availability of same-day reconnect varies greatly, depending on the time of year and time of day the retailer is authorizing the energize.

If the local governing authority requires a permit, ATCO Gas will contact the customer named on the ENR transaction to advise.

ATCO Gas will apply a reconnect fee to the Retailer/DSP for successful ENR as well as unsuccessful attempts found to be the responsibility of the customer. The reconnect fee (also called reinstatement fee) will be billed to the authorizing retailer on the first TBF following completion of the energize. Current reinstatement fees are found in Schedule C of the AG Terms and Conditions.

7.6.4 Irrigation Customers

Effective October 2021, ATCO has implemented changes to the Irrigation program. These changes were AUC approved and impact Rate Class IRR1.

Meters will remain active all year to give the customer to use natural gas whenever needed, all year.

Outside of irrigation season, October 1 to April 30, fixed distribution charges will be \$0.00. If a customer chooses to use gas during this timeframe, they will be charged the variable rate and consumption on their next billing period.

When a customer no longer requires natural gas service to their irrigation meter, the Retailer /DSP will issue a de-energize order. Reconnection fees will apply.

7.6.6 Canceling an ENR

In the event that the Retailer/DSP wishes to cancel an energize, contact **must** be made with the AG Customer Assistance Centre. There is no transaction to cancel an ENR. If the ENR was completed before Retailer notification was received, the Retailer will be required to re-issue a DER transaction if needed.

7.7 De-Energize Request (DER)

This process describes the Rule 028 transaction and processes involving a physical disconnect to a site. The table below illustrates the type of disconnection required and the appropriate process and/or required transaction.

Situations when DER transactions accepted

Retailers authorize AG to complete a physical disconnect of service by DER transaction. Retailer DER transactions are only accepted by AG in the following situations (See Rule 028 for reason code).

For information on the time of year and/or temperature conditions that prevent ATCO Gas from performing a retailer de-energize, refer to the Retailer Terms and Conditions Schedule B. During this period, the owner letter must be provided for residential de-energizes, email the letter to naturalgas@atco.com

DER transaction reason	Required Retailer information in DER transaction
Cut off for Non-Payment	<ul style="list-style-type: none">Name of site Customer being cut off for non-paymentDate the Retailer/DSP provided ten days written notice of pending disconnect to customerAmount of proof of paymentRetailer's credit and collections telephone number
Vacant Premises (no application to Retailer)	<ul style="list-style-type: none">Date since no application to Retailer
Temporary/seasonal turnoff	<ul style="list-style-type: none">Target dateCustomer RequestCustomer information, including current phone numbers

ATCO Gas will fail DER transactions for the following equipment-related physical disconnect situations

- Temporary meter removal
- Permanent meter removal
- Permanent service line removal (e.g. demolish property)

For the situations above, please advise the customer to contact the ATCO Gas call centre for assistance.

Scheduling of DER transactions

After the DER is received, AG will schedule the de-energize as part of its work plan based on daily de-energize maximum volumes for each AG service location. There are reasons the Company may have to delay or cancel the disconnect request. Reasons for failure are stated in Rule 028 as well as the ATCO Gas Retailer Terms and Conditions for Gas Distribution Service.

ATCO Gas complies with Rule 028 regarding sending the appropriate response transactions to a Retailer/DSP de-energize.

The Company reserves the right to turn off and may remove a meter for reasons including fire, safety, and lack of access provided for meter reading or facility upgrading. The Company will use the Site Metering Characteristics (SMC) transaction (Rule 028) to notify the Retailer/DSP of the change in site status.

7.8 Request Off-Cycle Meter Read (ROR)

The Company does not read meters for Site Customer or Retailer/DSP switches. It is the Retailer/DSP's responsibility to notify customers that estimating a meter reading will occur unless one of the following occurs.

- The Retailer/DSP initiates a Request Off-Cycle Read (ROR) transaction per Rule 028, or
- The customer provides a meter reading to ATCO Gas on the day the meter was read.

7.9 De-Select Request (DSR)

This Rule 028 transaction allows the Retailer to remove itself as the enrolled retailer, responsible to AG for service at a specific site.

The Retailer is responsible for informing the customer of the de-select.

Upon receipt of the DSR, the Company will notify the Default Supply Provider to enroll the site as of the effective date. If the de-selecting Retailer has chosen the de-select reason of "Retailer Drops Customer," the customer information provided by the Retailer with the DSR may be used by the DSP to establish a customer Account.

If an alternate Retailer successfully enrolls the site before the de-select date, the Company will notify the Default Supply Provider not to enroll.

Note: The effective date of a future-dated DSR is the first day the Default Supply Provider will enroll.

ATCO Gas complies with Rule 028 and issues the appropriate response files to a DSR to the current and new retailer.

7.10 Revoke De-Select Request (RDS)

This Rule 028 transaction permits a Retailer to revoke a De-Select Request (DSR) that was previously submitted as long as notification is received prior to the effective date in the DSR.

7.11 Revoke De-energize Request (RDR)

This Rule 028 transaction permits a Retailer/DSP may wish to cancel a request for de-energizing a site. It is strongly recommended this occur with the Retailer/DSP calling the AG Customer Assistance Centre first, followed by a Revoke De-energize Request (RDR) due to timing. The RDR transaction may not be processed until the next business day, during which time AG may have already turned off the service.

Upon receipt of the Retailer's/DSP's revoke, the Company will determine the status of the service and cancel the original request if the service has not been turned off.

The Retailer/DSP is responsible for informing the customer. The Company reserves the right to assess a charge to the Retailer/DSP for costs the Company has incurred if

it has already sent a serviceman to the site to undertake the work based on the original DER transaction.

The Company will advise the Retailer/DSP that an RDR was completed using the De-energize Failure (DEF) transaction.

NOTE: AG will not accept a revoke request from a Retailer who has not yet enrolled the site for the purpose of preventing the enrolled Retailer's DER.

7.12 Site Cycle Changes (SCC)

This Rule 028 transaction notifies retailers 30 days in advance of a change of billing cycle at a site and is also issued for every successful enrollment notification (SRN).

7.13 Site Profile Characteristics (SPC)

Every January 1st, for a change in profile class at a site from Low Use to Mid Use and from Mid Use to Low Use, the Site Profile Change (SPC) transaction will be sent by AG to the enrolled retailer. The SPC will be issued as outlined in Rule 028.

7.14 Site IDs

The Site ID is a unique 13-digit identification number for every delivery point served by ATCO Gas. The primary use of the Site ID is for Retailers/DSP to enroll sites. The Company will provide assistance to customers in order to find Site IDs if the Retailer/DSP cannot locate a Site ID within the posted Site ID List. Site IDs are available from the following two AG sources.

1. Site ID List (Site ID Address Book)

This file includes a list of all sites within AG's service territory and is available for download on the Company's website at www.atco.com. The sites are listed in a CSV (Comma Separated Value) file with standard content as specified by Rule 028. The Site ID number and service address (street and legal address) are provided as well as the meter number as of the date of list. To protect customers' privacy, the file does not include customer information. The file is updated daily. Retailers/DSP must use their own software to sort and query the CSV file.

2. ATCO Gas Call Centre

Site IDs are available to customers by calling the ATCO Gas Customer Assistance Centre at 310-5678 or by email to naturalgas@atco.com.

7.15 Meter Accuracy Dispute

This event covers circumstances including a high bill complaint.

In its normal course of business, AG is prepared to address customer and Retailer inquiries regarding the accuracy of meter readings and calculation of usage from those readings.

The Company focus is on the most recently billed meter reading and usage. Generally, this includes suggesting that the customer provide a meter reading to validate the most recently billed usage. If the meter reading used for billing appears accurate, AG will discuss usage history under the name of the current site customer, comparing the same customer's historical usage.

AG does not have a service to check the meter when the customer believes too much natural gas is being billed.

Should the customer disagree with the AG assessment that the measured usage is accurate, despite attempts to address the customer's concern, the Company will offer information regarding the meter dispute process. The Customer will have to initiate the dispute with Measurement Canada. There is a prepaid AG fee to the customer for meter disputes which is refunded if the meter is found to be out of tolerance. The current meter dispute explanation and fee are found in Customer Terms and Conditions for Gas Distribution Service. If the meter dispute process determines the meter is out of tolerance, the Company will also adjust the Retailer's/DSP's bill accordingly.

7.16 Request Settlement Data

The Company provides profiling and settlement information in accordance with the specifications outlined in Rule 028.

To request additional settlement data, the Retailer/DSP shall provide a written request to retailercontact@atcogas.com outlining the purpose for the additional settlement information. AG requires the reasons for the data request so it can quickly and efficiently respond to the needs of the Retailer/DSP. After the request is made, the Company will provide a written proposal of the type of work, time of delivery and charges necessary to provide the additional settlement information. All settlement information will be provided electronically to the Retailer/DSP.

7.17 Request Usage History from Company

ATCO Gas will provide usage history to Retailers/DSP under the conditions stated in its Retailer Terms and Conditions for Gas Distribution Service. Prepayment for historical usage history may be required.

Retailers/DSP are responsible for obtaining the correct authorization from the Customers for the period of time.

Retailers/DSP have two options regarding usage history:

1) Request For Usage (RFU) transaction

ATCO Gas complies with the rules regarding the provision of historical natural gas consumption as specified in the AUC Rule 010 found on the AUC's website www.auc.ab.ca.

2) Request for Billed Consumption

Historical usage history may be provided by ATCO Gas upon receipt of the signed Authorization and Release Form, Appendix F as stated in the Customer Terms and Conditions

The signed Authorization and Release Form must be signed by an individual already named to AG as an AG Customer Contact. In most cases, Retailers do not provide individuals' names to AG through a UCI transaction when the Site Customer is a company or organization.

To make requests for billed consumption, call or email the ATCO Gas call centre.

The customer will be provided at no additional cost up to the most recent 12 months of billed consumption for the site. If additional historical periods are required, prepayment of the current cost recovery fee will be required first.

Chapter 8 Prudential Requirement Policies

8.1 Initial Credit Information

All Retailers and Self-Retailers entering into a Retail Service Agreement with AG must complete a Retailer of Record and Credit Application Form as shown in Appendix B. AG will use the information provided in the credit information section of the application form to establish the Retailer's initial prudential security requirement, which must be received before the Company will provide Distribution Access Service to the Retailer. This evaluation will be conducted in accordance with Article 11 of the Retailer Terms and Conditions for Gas Distribution Service.

As part of this process, Retailers are required to provide; (i) their credit rating from a major reputable bond rating service Company and (ii) their initial customer and load determinates.

8.2 Setting of Prudential Requirements

A Retailer is required to provide security in accordance with the Company's Retailer Terms and Conditions for Gas Distribution Service found on the ATCO website www.atco.com

8.3 Financial Obligations

Initial financial obligations for the Retailer will have to be determined when a Retailer first requests service from the Company. AG will undertake this evaluation with the Retailer's assistance based on the number of customers and load served by the Retailer on the Company's price schedule. ATCO representatives will assist the Retailer in determining the most suitable price schedule for the Retailer's customer.

8.4 Drawing-on Security

As noted in Section 8.2, AG will monitor the Retailer's financial obligation on a daily basis to ensure it does not exceed its credit limits as defined above. In addition, if a Retailer fails to pay any amount billed, the Company will apply all or a portion of the Retailer's security to the unpaid amount. This process will be monitored as follows (*in business days*):

Day 1: The Company will send an electronic bill file to the Retailer for the billing cycle.

Day 12: Preauthorized payment withdrawal from the Retailer's Account.

Day 13: Normally, the Company will first make a call to the Retailer advising of the situation. The Company will follow up in writing via email, fax, or letter that it is in default of its payment and that it has three business days to pay arrears. In addition, arrears are subject to the Late Payment Charge as defined in the Company's Rate Schedules.

Day 16: Overdue notice expires.

- (i) If the Retailer has qualified based on its bond rating [see section 8.2(a)], the Company will request the Retailer to provide additional security in a form outlined in section 8.2(b) within a specified time.
- (ii) If the Retailer has qualified based on a guarantee provided by a person with a qualifying bond rating, the Company will make a demand on that guarantee.
- (iii) If the Retailer has provided a security in a form outlined in 8.2(b), the Company will draw on the security and the Retailer will be required to replenish the security within five business days.

To be Advised by AG: If the Retailer has failed to provide additional security or the guarantor has not honoured the guarantee provided, the Company will suspend the provision of further Distribution Access Service to the Retailer and reserves the right to discontinue Distribution Access Service entirely to the Retailer.

8.5 Interest Paid on Security

Interest on each Retailer's cash security deposit held by the Company will be calculated at the rate specified from time to time in The Residential Tenancies Act. Interest will be paid to the Retailer annually. If the amount of annual interest equals or exceeds \$50 a T5 Statement of Investment Income will be issued by the Company and sent to the Retailer in accordance with Canada Customs and Revenue Agency policy.

8.6 Confidentiality

All information provided by the Retailer in relation to its financial standing and designated by the Retailer as confidential will be treated as such under the Confidentiality Agreement between the Retailer and the Company. The terms and conditions of the Confidentiality Agreement are set out in Appendix I.

Chapter 9 Distribution Billing and Payment

9.1 Tariff Billing File (TBF)

Tariff billing file production and publication details are described in Rule 004 Alberta Tariff Billing Code. AG publishes Tariff Billing Files for each of its 20 billing cycles. Billing cycles are linked to scheduled read cycles; therefore, a retailer that has customers with scheduled read cycles that span all 20 cycles will tariff bill files for all 20 cycles. Generally, one billing cycle is processed each business day, but in some cases, two billing cycles will be processed in one business day.

Chapter 10 Compliance Testing Protocol

10.1 Introduction

The Retailer/DSP must fulfill the requirements of the compliance testing protocol, as amended from time to time, before the Company can provide Distribution Access Service to the Retailer/DSP. The purpose of the compliance testing protocol is to set forth procedures for testing and evaluating compliance with the Natural Gas Settlement System Code.

10.2 Compliance Testing & Certification

- (a) The Company uses the compliance testing to ensure that the Retailer/DSP meets the standards defined by the Company and the Natural Gas Settlement System Code. The compliance test focuses on the electronic transactions supporting enrollment and updating Customer Information. In particular, the various tests cover proper formulation, receipt, processing, form and content of, and response to key transactions.
- (b) A Retailer/DSP may fail any compliance test up to two times, after which failures the Retailer/DSP may reschedule and retake the test. Should a Retailer/DSP fail any test three times, the Retailer/DSP must wait one Month or some other time period designated by the Company before retesting will be allowed. In the event a Retailer/DSP requires re-testing, the Retailer/DSP must successfully complete all compliance tests in order to obtain certification. Compliance tests must be performed successfully for each Retailer ID registered with the Company.

10.3 Testing Support

The Company will provide testing support by telephone and e-mail for Retailers/DSP participating in the compliance testing process. The Company will use reasonable efforts to communicate the test results to the Retailer within five (5) business days.

10.4 Prerequisites

The Retailer/DSP must notify met all qualifications (Appendix A).

The Retailer/DSP must have purchased and installed VLTrader™.

The Retailer/DSP must obtain a properly authorized digital server certificate from the VL Trader vendor. The digital certificate will be used to validate the Retailer's/DSP's access to the VLTrader™ server.

10.5 Compliance Tests

- All Retailers and the DSP must successfully perform the tests listed in the table below.
- Retailers/DSPs who register more than one Retailer ID must successfully complete Test 1 for each additional Retailer ID.
- All test files must contain three or more records.

Test	Description	Expected Result
1	<p>Send Select Retailer (SRR) transaction and Update Customer Information (UCI) with the mandatory fields in Rule 028;</p> <ul style="list-style-type: none"> • Transaction Abbreviation • Transaction Date Time • Retailer ID • Business Function ID • Distributor ID • Site ID <p>Note: ATCO Gas requires, at minimum, a Customer Name and telephone number.</p>	<p>SRR and UCI will be accepted by the Company.</p> <p>A reply SRN will be sent to the retailer. There is no reply to the UCI except where it has been rejected; in this case, the UCI will be returned with a suffix "R."</p>
2	<p>Send Select Retailer (SRR) transaction and Update Customer Information (UCI) with the following required fields;</p> <ul style="list-style-type: none"> • Customer Phone • Customer Mailing Address • Site Contact • Site Contact Phone 	<p>SRR and UCI will be accepted by the Company.</p> <p>A reply SRN will be sent to the retailer. There is no reply to the UCI except where it has been rejected; in this case, the UCI will be returned with a suffix "R."</p>
3	<p>Send Select Retailer (SRR) transaction and Update Customer Information (UCI), omitting the Site ID from both transactions.</p>	<p>SRR and UCI will be rejected by the Company.</p> <p>A reply SRN will be sent to the retailer. There is no reply to the UCI except where it has been rejected; in this case, the UCI will be returned with a suffix "R."</p>
4	<p>Send Select Retailer Request (SRR) without the Update Customer Information (UCI).</p>	<p>SRR will be rejected by the Company.</p> <p>A reply SRN will be sent to the retailer. There is no reply to the UCI except where it has been rejected; in this case, the UCI will be returned with a suffix "R."</p>

10.6 Process Rejections

As Rule 028 specifications, ATCO will return records or entire files it is unable to process to the Retailer/DSP in a file named the same as the file ATCO received with an “R” suffix. Rejected records will have the transaction status code updated to reflect the rejection reason.

10.6.1 Rejected Files

In addition, ATCO will reject entire files if any of the following conditions are met in the file:

1. The transaction ID in the filename is not a transaction ID AG is expecting.
2. The sender ID in the filename does not match the inbox the file was received in.
3. The receiver ID in the filename is not an expected ID for this type of transaction.
4. The date in the filename is not within the last ten days or is in the future.
5. Any record within the file has a different transaction ID than the one in the filename.
6. Any record within the file has a different sender ID than the one in the filename.
7. Any record within the file has a different receiver ID than the one in the filename.
8. Any record within the file contains too many commas.
9. Any record within the file contains too few commas.
10. A file with the same name was received on a day other than the current day.

When a file is rejected, AG will immediately place the file, as it was received, into the outbox corresponding to the inbox it was received in. The file name will remain the same.

10.6.2 Duplicate Files

If a file is received with the same name as another file that was previously received on the current day, the new file will overwrite the old file, and only the new file will be processed.

If a file is received with the same name as another file that was previously received on a previous day, the new file will be rejected.

10.6.3 Deleting Files from the VLTrader™ Server

All files that are placed on the VLTrader™ server, whether they have been picked up or not, will be deleted 30 days after they are created. No notification will be provided when a file is deleted.

Chapter 11 Load Settlement

INTRODUCTION

The system used for performing Load Settlement is called the Daily Forecasting and Settlement System (DFSS). The DFSS provides aggregate and site-level consumption for Backcast and Settlement to Retailers/DSP. DFSS also provides aggregate consumption through a system interface with IRIS to the Retailer Service Accounts. The DFSS performs the necessary processes to be able to estimate and settle natural gas consumption for each retailer/DSP site served by ATCO Gas. For more information, refer to the Rule 028 Natural Gas Settlement System Code.

PROCESSES

ATCO Gas requires the capability of running the following three types of processes:

1. Forecast Gas Usage
2. Backcast Gas Usage
3. Settlement

FORECAST

The daily forecast is the expected total Retailer/DSP consumption for a gas day. DFSS calculates forecast usage by using forecasted temperatures in a forecasting model. Forecasting models are specific to distribution zone, weather zone, and profile class.

For Ultra High Use and High Use sites, with AMR data, DFSS uses the Proxy Day method for forecasting. The Proxy Day method involves a search of recent days for a day having similar characteristics (e.g., similar temperatures) as the forecast gas day. If a match is found, then the proxy day's AMR data is used as a forecast estimate.

Timing of Daily Forecasts

Three forecasts are produced for each day as follows:

F1 – Each day, a forecast is completed and reviewed for the next gas day for each retailer/DSP.

F2 – Each day, a forecast is completed and reviewed for the current gas day for each retailer/DSP.

F3 - Each day, an updated forecast is completed and reviewed for the current gas day for each retailer/DSP using more current temperature information.

The specific timing guidelines for the forecasts are stated above in Section 6.5.

Forecasting Models

The DFSS forecasting models estimate the impact that one or more variables have on usage. The main predictor in most cases is temperature, but the model variables may also include other predictors such as wind speed, season, and day type. The variable values are inserted into the appropriate equations, and a model forecast is generated. The equation

below is an example of the models which are used in DFSS for forecasting usage. Each variable in the equation is defined in Table 1.

Formula 1 (Example of forecasting model):

$$\begin{aligned} \text{ModelForecastofDaily Usage}(GJ) = & \text{Intercept} + \hat{\beta}1 * \text{ForecastTemperature} \\ & + \hat{\beta}2 * \text{Weekend} + \hat{\beta}3 * \text{Summer} \\ & + \hat{\beta}4 * (\text{Summer} * \text{ForecastTemperature}) \end{aligned}$$

Table 1

Variable	Definition
ModelForecastofDailyUsage	Model forecast of gas day usage for an average customer for a particular customer class, distribution zone and weather zone measured in GJs.
Intercept	The intercept estimates the daily forecast usage when all values of the equation variables are set equal to zero.
ForecastTemperature	Average 24-hour forecast temperature in degrees Celsius for the gas day. There is normally an inverse relationship between temperature and daily usage.
Weekend	On weekends, usage levels differ from weekdays.
Summer	In summer months (June, July, August), usage is typically lower as compared to other months.
Summer*ForecastTemperature	Interaction term of summer and temperature. Warmer temperatures cause less of a decline in usage in the summer months as compared to the other months.
$\hat{\beta}1, \hat{\beta}2, \hat{\beta}3, \hat{\beta}4$	Coefficients showing the estimated relationship between explanatory variables and ModelForecastof DailyUsage.

When forecasting usage, the primary variable in the model is the average 24-hour forecast temperature for the gas day. Weather data is provided by DTN/Meteorlogix; the temperature information is provided for six weather zones: Edmonton, Grande Prairie, Fort McMurray, Red Deer, Calgary, and Lethbridge. Each site is assigned to one of the six weather stations based on geographic location to ensure that region-specific temperatures are applied to the model forecasts.

Formula 1 generates an average forecast usage for a particular group of customers (for a particular customer class, distribution zone and weather zone combination). The next step is to calculate the daily forecast usage for each individual site id. The model forecast is scaled to each site based on historical usage provided by CIS. A scaling methodology is used to adjust the model generated group forecast either up or down based on differences between the site’s gas usage and the average customer’s gas usage.

The total daily forecast for a Retailer/DSP is calculated by summing all of their sites’ forecasts.

When the B1 and F2 are processed each morning, DFSS receives two weather data files from DTN, an observed and a forecasted. The observed weather data file contains actual temperatures up to 3:00 AM for the current gas day. The forecasted weather data file contains forecasted temperatures for the current calendar day, as well as the following calendar day. DFSS uses a combination of the observed and forecasted weather data files to derive gas day temperature for B1. Table 2 summarizes the time periods used in each forecast and backcast:

Table 2 (Temperature Derivation Timeframes for a Typical Calendar Day):

<u>Measurement Type</u>	<u>Hours of Observed (Actual) Temperatures</u>	<u>Hours of Forecasted Temperatures</u>
B1	Calendar Day 1 08:00 AM to Calendar Day 2 02:59 AM	Calendar Day 2 3:00 AM to 7:59 AM
F2	N/A	Calendar Day 2 08:00 AM to Calendar Day 3 07:59 AM
F3	Calendar Day 2 08:00 to 09:59 AM	Calendar Day 2 10:00 AM to Calendar Day 3 07:59 AM
F1	N/A	Calendar Day 3 08:00 AM to Calendar Day 4 07:59 AM

Ultra High Use and High Use Sites

There is an alternative forecasting method available for Ultra High Use and High Use sites, which have daily AMR data. DFSS receives daily gas day usage for these sites. Therefore, the preferred method for forecasting these sites is the “Proxy Day” selection method. The Proxy Day method involves a search of recent days for a day having similar characteristics (e.g., similar temperatures and/or day type) as the forecast gas day. If a match is found, then the proxy day’s AMR data is used as a forecast estimate. No scaling is required with the proxy day method because the AMR data is site-level data.

Table 3 (Proxy day selection example):

Order of Search	Potential Proxy Day	Day Type	Actual Temperature (Degrees Celsius)	AMR Daily Usage for a Site (GJ)
1	Yesterday	Weekday	-15.2	8.8
2	2 Days Back	Weekday	-6.0	4.5
3	3 Days Back	Weekday	-9.1	6.7
:	:	:	:	:
29	29 Days Back	Weekend	-3.9	3.1
30	30 Days Back	Weekday	-2.2	2.5

Suppose the forecast date (the target date) is a weekday with a forecast temperature of -5 degrees Celsius. DFSS will search for a suitable proxy day for up to 30 days in the past. A day is considered to be a match to the target date if certain defined criteria are met on day type and/or temperature variables. Which variables are of importance depends on the profile class of the site. For this case, suppose both day type and temperature must match. Then the day type of the proxy day must be the same as the target day (weekday for this example), and the temperature must be within a defined limit of +/- 2 degrees Celsius (-3.0 to -7.0 degrees Celsius for this example).

As shown in Table 3, DFSS starts its search one day back with yesterday, which is a weekday but has an actual temperature of -15.2, which is outside the +/- 2-degree range. Since yesterday was unsuccessful, the search will continue two days back. This day (see the shaded row in the chart) is a match because it is a weekday with an actual temperature of -6.0 degrees which is within the +/- 2-degree range. The AMR daily usage of 4.5 GJs will become the target day’s forecast usage for the site. No scaling is performed here because the proxy day’s AMR usage is site-level data.

In the case that no proxy day is found for a particular site, DFSS will use a forecast model with scaling to estimate that site (see the “Forecasting Model” description above).

BACKCAST

Each morning, a Backcast is completed and reviewed for the previous gas day for each Retailer/DSP. The previous gas day is defined as the 24 hour period between 8:00 am the previous day to 7:59 am current day. The daily Backcast provides an estimate of the actual retailer/DSP usage for the previous gas day. DFSS calculates previous gas day’s usage by using actual temperatures in its forecasting models. For Ultra High Use and High Use sites, with AMR data available, DFSS will instead use the previous day’s actual AMR data to estimate backcast usage.

The specific timing guidelines for the Backcast are stated above in Section 6.5.

Backcast Models

The forecasting model shown in Formula 1 is also used for estimating a Backcast. For a Backcast, Formula 1 uses actual temperature for the previous gas day (or incorporates as much hourly actual temperature information as is available). The Backcast usage obtained from Formula 1 is for an average customer only. The model Backcast is scaled to each site based on historical usage provided by CIS. Scaling is used to adjust the model forecasts either up or down based on differences between the site's gas usage and the average customer's gas usage. The total daily backcast for a retailer/DSP is calculated by summing all of their sites' Backcasts.

Ultra High Use and High Use Sites

There are alternative backcasting methods available for Ultra High Use and High Use sites, which have daily AMR data. The first choice when Backcasting ultra high use and high-use sites is to use AMR data from the previous day. No scaling is performed because yesterday's AMR usage is already site-level data. If AMR data is unavailable for the Backcast day, DFSS will apply the proxy day selection method using the same logic as shown in Table 3. If a proxy day cannot be found, DFSS will use a Backcast model (see the Backcast Models section above).

CONSUMPTION SETTLEMENT

DFSS will produce monthly consumption settlements for each Retailer/DSP. The goal of a settlement is to determine the actual amount of gas consumed each day in the settlement month for each site. The Settlement Month is a calendar Month. The Settlement allocates each site’s DCM usage record to each gas day within the Settlement Month. The total daily Settlement amount for a retailer/DSP will be calculated by summing all of their sites’ Settlements for the Settlement Month.

Three Settlements will be run for each Month. These are Initial Monthly Settlement (S1), Interim Settlement (S2) and Final Settlement (S3). The timing of the Settlement runs is described in more detail in the Natural Gas System Settlement Code, Section 4.3.3: Monthly Settlement.

Consumption Settlement Calculation

In order to settle a particular Month (the “target month”) for a particular site, DFSS gathers the site’s DCM Usage Records, which cover one or more days in that Month and then applies a settlement profile to each DCM record. The settlement profile is a representation of gas usage over the allocation period. The profile allocates the total period usage to the days within the DCM start and end dates. In DFSS, there are three types of profiling methods: 1) Sample, 2) Models, and 3) Individual AMR data. Formula 2 shows how the DCM is allocated to a day within the DCM period using a profile. Regardless of the profiling method, the equation in Formula 2 shows how one day is settled using a DCM record and profile.

Formula 2 (Settling a particular site by using a model):

$$Settlement\ Usage\ for\ Site\ (GJ) = Site'\ sDCMUsage\ Record\ (GJ) * \frac{Daily\ Profile\ (GJ)}{Period\ Profile\ (GJ)}$$

As a summary, Table 4 displays the hierarchy of calculation methodologies employed by DFSS for forecast, backcast, and settlement runs.

Table 4. Forecast, Backcast and Consumption Settlement Methodologies

Customer Class	Order of Operation	Forecast	Backcast	Settlement
Low Use Sites Mid Use Sites	Only Choice	Model	Model	Model
Ultra High Use & High Use Sites	1 st Choice	Proxy Day	AMR Data	AMR Data
	2 nd Choice	Model	Proxy Day	Proxy Day
	3 rd Choice		Model	Model

DFSS OUTPUTS

DFSS outputs daily forecast, Backcast, and settlement information summed by Retailer/DSP to IRIS. Retailers/DSP are then able to view the results in their Accounts on IRIS. DFSS also sends forecast, Backcast, and settlement files to Retailers/DSP via VLTrader™. Table 5 summarizes the files that are sent to Retailers/DSP for the various types of settlement runs.

Table 5. Files Released to Retailers

File Type	Definition	Settlement Type
WSI – Wholesale Settlement Information	Total settlement usage for each day summarized by retailer and distribution zone	Forecast, Backcast, Settlement
WSS – Wholesale Settlement Summary	Total settlement usage for a month summarized by retailer and distribution zone	Settlement
WSD – Wholesale Settlement Details	Settlement usage by day for each site	Backcast, Settlement
SPV– Settlement Profile Value Transaction	Total settlement usage for each day summarized by profile class, distribution zone, and weather zone	Forecast, Backcast, Settlement

For more information on the above files sent to retailers for settlement, including file layouts, refer to Rule 028.

APPENDIX A Qualification Checklist

The checklist below provides information regarding the general process for establishing access service.

Send any inquiries regarding becoming a retailer on the ATCO Gas system to retailercontact@atcogas.com.

1.	Applicant notifies ATCO Gas with a letter of intent to serve gas customers and the proposed date for this service to begin.
2.	ATCO Gas issues qualification instructions, including prudential requirements. See Appendix A for the explanation.
3.	Retailer provides to ATCO Gas signed original copies (by mail or fax) of required documentation which are as follows: Distribution Access Agreement found at www.atco.com , Retailer Terms and Conditions for Gas Distribution Service. Appendix B: Retailer of Record and Credit Application Form Appendix D – Preauthorized Payment Agreement OR Appendix D – Electronic Funds Transfer Appendix E – Representation and Warrant Agreement Appendix G – Letter of Credit Appendix H – Guarantee Appendix I – Confidentiality Agreement Appendix J – Agency Appointment Agreement (if the retailer will have another company act on their behalf). A letter stating that the retailer will comply with the Fair Trading Act, Rule 004 and Rule 028.
4.	ATCO Gas notifies the Retailer that it has received all applicable forms and agreements or states the deficiencies.
5.	ATCO Gas confirms all prudential requirements are confirmed.
6.	ATCO Gas provides contact information for Retailers to begin compliance testing.
7.	Retailer provides the name of the Retailer Service Account administrator.
8.	ATCO Gas sets up the Retailer Service Account in the Imbalance Reporting Information System (IRIS).
9.	Retailer completes compliance testing successfully.
10.	ATCO Gas notifies Retailer date it may begin enrollments.
11.	Retailer begins enrollments.



APPENDIX B Retailer of Record and Credit Application Form

MEMORANDUM OF AGREEMENT made the (day) of (month), (year)

APPENDIX to the Distribution Access Service Agreement between <RETAILER NAME>, <RETAILER BUSINESS NUMBER>, and ATCO Gas and Pipelines Ltd.

A. GENERAL INFORMATION	
1. Legal Business and Corporate Name:	
2. Business Number:	
3. Doing Business As (DBA) Name (if different than legal business name):	
4. Business Street Address:	
5. Mailing Address (if different that Business Address):	
6. Primary Contact Person Information for Commercial/Business Matters	
6. Alternate Contact Person Information for Commercial/Business Matters	
Name(s):	Name(s):
Address:	Address:
Phone #:	Phone #:
Email:	Email:
Fax #:	Fax #:
7. Primary Contact Person Information for Data Exchange/Billing Matters	
7. Alternate Contact Person Information for Data Exchange/Billing Matters	
Name(s):	Name(s):
Address:	Address:
Phone #:	Phone #:
Email:	Email:
Fax #:	Fax #:
8. Primary Contact Person Information for Compliance Testing Matters	
8. Alternate Contact Person Information for Compliance Testing Matters	
Name(s):	Name(s):
Address:	Address:
Phone #:	Phone #:
Email:	Email:
Fax #:	Fax #:
9. Retailer Identification Number(s):	
(1) _____	(4) _____
(2) _____	(5) _____
(3) _____	(6) _____
Estimated Daily Usage of sites to be enrolled: _____ MCF/GJ (please circle)	

(B) BILLING INFORMATION (required for electronic payment)	
1. Name of Financial Institution:	
2. Address:	
3. Account #:	
4. Account Name:	
Email: _____	ATCO Gas' Website at www.atco.com :

(C) CREDIT INFORMATION	
1. Chief Executive Officer:	
2. Name:	
3. Phone #:	
4. Fax #:	
5. Chief Financial Officer:	
6. Name:	
7. Phone #:	
8. Fax #:	
9. Is your Company publicly traded? If yes, provide Fiscal Year End (Month/Day): _____ If no, complete next question.	
10. Primary/Alternate Contact Person Information for Prudential Requirements:	
11. Name(s):	
12. Address:	
13. Phone #:	
14. Email:	
15. Fax #:	
16. Credit Rating Agency	
17. Credit Rating	
18. SENIOR PERSON WHO WOULD AUTHORIZE ALL RETAILER AGREEMENTS	
19. Name:	
20. Address:	
21. Phone #:	
22. Email:	
23. Fax #:	
24. ACCOUNTS PAYABLE ARREARS ISSUES CONTACT	
25. Name:	
26. Address:	
27. Phone #:	
28. Email:	
29. Fax #:	

APPENDIX C Preauthorized Payment Agreement

PREAUTHORIZED PAYMENT AGREEMENT ("AUTHORIZATION") made the (day) of (month), (year)

BETWEEN: **(RETAILER/DSP NAME)**
 (address)

(hereinafter called the "Retailer")

- and -

ATCO GAS AND PIPELINES LTD., a body corporate with its Head Office in
the City of Edmonton in the Province of Alberta ("ATCO Gas" or "Company")

WHEREAS ATCO Gas has entered into a Distribution Access Service Agreement ("Distribution Access Service Agreement") with the Retailer/DSP, and the Retailer/DSP has requested to make payments arising from the provision of Distribution Access Service via preauthorized electronic payment.

The Retailer/DSP and the Company agree as follows:

1. Subject to Paragraph 11 hereof, the Retailer/DSP shall make payments to the Company pursuant to the Distribution Access Service Agreement through preauthorized payment as set forth in this Authorization.
2. The Retailer/DSP acknowledges and agrees that this Authorization is provided for the benefit of ATCO Gas and the Retailer's/DSP financial institution and is provided in consideration of the Retailer's/DSP's financial institution agreeing to process debits against the Retailer's/DSP's Account in accordance with the Rules of the Canadian Payments Association.
3. The Retailer/DSP represents, warrants and guarantees that all persons whose signatures are required to sign on the Account (as hereinafter defined) have signed the Preauthorized Payment Agreement.
4. The Retailer/DSP authorizes ATCO Gas to draw on the Account ("Account") listed below:

(Retailer'/DSP Name) Financial Institution Information:

Financial Institution Name:

Address:

Account Name:

Account Number:

5. The Retailer/DSP will undertake to inform ATCO Gas, in writing, of any changes in the Account information provided in this Agreement prior to the next due date of the preauthorized debit ("PAD") following such change.
6. Either party may terminate this Authorization at any time upon 10 business days written notice to the other party; provided however, that the Retailer/DSP shall remain liable to make Payments due during this notice period as provided herein. Termination of this Authorization shall not relieve the Retailer/DSP from its obligations under the Distribution Access Service Agreement or the Retailer Terms and Conditions for Gas Distribution Service. The Retailer/DSP acknowledges that, in order to revoke this Authorization, written notice of revocation must be provided to and received by ATCO Gas.
7. The Retailer/DSP acknowledges and agrees that provision and delivery of this Authorization to ATCO Gas constitutes delivery by the Retailer to the Retailer's financial institution.
8. The Retailer/DSP acknowledges and agrees that its financial institution is not required to verify that a PAD has been issued in accordance with the particulars of the Retailer's/DSP's Authorization, including but not limited to the amount thereof.
9. The Retailer/DSP acknowledges and agrees that its financial institution is not required to verify that the reason for payment for which the PAD was issued has been fulfilled by ATCO Gas as a condition to honoring a PAD issued or caused to be issued by ATCO Gas on the Retailer's Account.
10. If a payment due date falls on a date on which the electronic transfer cannot be completed because the electronic system for receipt of this Payment is, during such business day, incapable to make or receive an electronic transfer, such payment due date shall be deemed to be the next business day on which such transfer can be completed. If the transfer has failed for reasons out of the Retailer's/DSP's control, the Retailer/DSP shall not incur any late payment penalty. Any such delay shall not extinguish any obligation of the Retailer/DSP to pay the Company as soon as practical after it is notified of such failure.
11. Upon at least five (5) business days prior written notice to the Company, the Retailer/DSP may make any payment arising from Distribution Access Service by reasonable means other than as set forth in this Authorization, including, without limitation, by certified cheque, so long as such payment is made with immediately available funds.
12. The Company shall not be liable to the Retailer/DSP or to the Retailer's/DSP's financial institution for any losses, claims, damages, expenses (including without limitation, lawyer's fees on a solicitor and own client basis), actions or causes howsoever arising directly or indirectly from the Company's use of this Authorization.
13. This Authorization shall ensure to the benefit of and be binding and enforceable by the parties hereto and their respective executors, administrators, successors and, where permitted, assigns.

14. The Retailer/DSP and the Company shall comply with the nondisclosure obligations set forth in Paragraph 16 of the Distribution Access Service Agreement. The Parties hereby acknowledge and agree that all information provided by the Company to the Retailer/DSP pursuant to this Authorization shall constitute Confidential Information for the purpose of the Distribution Access Service Agreement, regardless whether such information has been marked as “proprietary” and/or “confidential”. The Retailer/DSP shall indemnify and save harmless the Company, and its directors, officers, employees, Agents and representatives (“Indemnified Parties”) from any and all damages, costs, expenses (including, but not limited to, attorney fees on a solicitor and own client basis), losses or claims incurred by such Indemnified Parties directly or indirectly resulting or arising from a disclosure of the Company’s Confidential Information provided hereunder.

15. Contacts or Notices required with respect to this Agreement shall be directed as follows:

ATCO Gas and Pipelines Ltd.

10035 - 105 Street Edmonton, Alberta
T5J 2V6

Contact Name: Account Financial Planning

Telephone No.: 780-420-3903

Retailer Name

(address)

Contact Name:

Alternate Contact name:

Telephone No.:

Alternate:

IN WITNESS WHEREOF the Parties have executed this Agreement as of the day and year first above mentioned.

[RETAILER/DSP NAME]

ATCO GAS AND PIPELINES LTD.

Per: _____
Name: _____
Title: _____

Per: _____
Name: _____
Title: _____

APPENDIX D Electronic Funds Transfer Agreement

ELECTRONIC FUNDS TRANSFER AGREEMENT ("EFT Agreement") made the (day) of (month), (year)

BETWEEN: **(RETAILER/DSP NAME)**

(address)

(the "Retailer")

- and -

ATCO GAS AND PIPELINES LTD., a body corporate with its Head Office in the City of Edmonton in the Province of Alberta ("ATCO Gas" or "Company")

WHEREAS the Company has entered into a Distribution Access Service Agreement ("Distribution Access Service Agreement") with the Retailer/DSP pursuant to the Retailer Terms and Conditions for Gas Distribution Service, and in that agreement the Retailer has agreed to make payments arising from the provision of Distribution Access Service via an electronic funds transfer to the Company's account.

The Retailer/DSP and the Company agree as follows:

1. Subject to Paragraph 7 hereof, the Retailer shall make all payments ("Payments") to the Company pursuant to the Distribution Access Service Agreement through an electronic funds transfer to the Company's account as set forth in this EFT Agreement.
2. The Retailer/DSP shall make Payments by electronically transferring funds to the Company's account described below:

Bank of Montreal	Bank:	001
340 – 7th Avenue SW	Transit:	00109
Calgary, Alberta	Account:	0001-916
T2P 0X4		

3. The Company shall inform the Retailer/DSP of any changes in the account information provided in this EFT Agreement prior to the next due date of any invoice issued by the Company to the Retailer pursuant to the Distribution Access Service Agreement.

-
4. The Retailer/DSP must provide notification (“EFT Notification”) to the Company, by fax or e-mail, of each electronic funds transfer (“EFT”) ON OR BEFORE the date such funds are deposited by the Retailer/DSP. The EFT Notification shall include each the Company statement account number to be paid, the amount to be applied to each account, the total amount of the deposit to be made by EFT and the deposit date. If the Company does not receive any of the information required hereunder, the Retailer/DSP shall be responsible for any late penalty charges that result. The EFT Notification shall be sent to:

By fax: (780) 508-4826

By email: paymentprocessing@atco.com

5. Either party may terminate this EFT Agreement at any time, upon 10 business days written notice to the other party; provided however, that the Retailer shall remain liable to make any Payments due during this notice period as provided herein. Termination of this EFT Agreement shall not relieve the Retailer/DSP from its obligations under the Retail Service Agreement or the Retailer Terms and Conditions for Gas Distribution Service.
6. If a Payment due date falls on a date on which the EFT cannot be completed because the electronic system for receipt of this Payment is, during such business day, incapable of receiving an EFT, such payment due date shall be deemed to be the next business day on which such EFT can be completed. If the EFT has not been completed on the due date for reasons beyond the Retailer’s/DSP’s control, the Retailer shall not incur any late payment penalty. Any such delay shall not diminish the obligation of the Retailer to pay the Company as soon as practical after it is notified of such failure.
7. Upon at least five (5) business days written notice to the Company, the Retailer/DSP may make any payment arising from the Distribution Access Service Agreement by reasonable means other than by EFT including, without limitation, by certified cheque, provided such payment is made with immediately available funds.
8. The Retailer/DSP shall, at its sole expense, provide and maintain the equipment, security procedures, hardware, software, services, testing and connections necessary to effectively and reliably comply with the terms of this EFT Agreement.
9. This EFT Agreement shall ensure to the benefit of and be binding and enforceable by the parties hereto and their respective executors, administrators, successors and, where permitted, assigns.
10. The Retailer/DSP and the Company shall comply with the nondisclosure obligations set forth in Paragraph 16 of the Distribution Access Service Agreement. The Parties hereby acknowledge and agree that all information provided by the Company to the Retailer pursuant to this EFT Agreement shall constitute Confidential Information for the purpose of the Distribution Access Service Agreement, regardless whether such information has been marked as “proprietary” and/or “confidential”. The Retailer/DSP shall indemnify and save harmless the Company, and its directors, officers, employees, Agents and representatives (“Indemnified Parties”) from any and all damages, costs, expenses (including, but not limited to, attorney fees on a solicitor and own client basis), losses or claims incurred by such Indemnified Parties directly or

indirectly resulting or arising from a disclosure of the Company's Confidential Information provided hereunder.

11. Neither Party will be liable to the other for the acts or omissions of the Company's financial institution.
12. If any provision of this EFT Agreement or the application thereof is to any extent held to be invalid or unenforceable, such provision shall be deemed to be severed from this EFT Agreement, and the remainder of this EFT Agreement shall not be affected and shall continue in full force and effect, enforceable to the fullest extent permitted by law or in equity.
13. Each Party agrees to execute and deliver such additional documents and instruments and to perform such additional acts as may be necessary to perform all of the terms and conditions of this EFT Agreement and the transactions contemplated hereby.
14. Subject to paragraph 4, contacts or notices required with respect to this EFT Agreement shall be directed as follows:

ATCO Gas and Pipelines Ltd.

10035-105 Street

Edmonton, Alberta T5J 2V6

Contact Name: Account Financial Planning

Telephone No.: (780) 420-3903

Retailer Name

(address)

Contact Name:

Alternate Contact Name:

Telephone No.:

Alternate:

IN WITNESS WHEREOF THE Parties have executed this EFT Agreement as of the day and year first above mentioned:

[RETAILER NAME]

ATCO GAS AND PIPELINES LTD.

Per: _____

Per: _____

Name: _____

Name: _____

Title: _____

Title: _____

APPENDIX E Representation and Warrant Agreement

I/We _____, represents and warrants to ATCO Gas and Pipelines Ltd. as follows each time that the Retailer requests ATCO Gas and Pipelines Ltd. to disclose to the Retailer historical gas consumption information for a site and acknowledges that ATCO Gas and Pipelines Ltd. is relying on such representations and warranties in disclosing the requested historical consumption information to the Retailer/DSP:

- (a) The Retailer/DSP is a party to a DISTRIBUTION ACCESS SERVICE AGREEMENT with ATCO Gas and Pipelines Ltd. and is bound by the obligations and liabilities under the DISTRIBUTION ACCESS SERVICE AGREEMENT and ATCO Gas and Pipelines Ltd's RETAILER TERMS AND CONDITIONS FOR GAS DISTRIBUTION SERVICE.
- (b) The Retailer/DSP has obtained from each of the customers to which the requested historical consumption information relates, all consents that are required under all applicable laws, for ATCO Gas and Pipelines Ltd. to disclose to the Retailer/DSP, and for the Retailer/DSP to receive from ATCO Gas and Pipelines Ltd. such historical consumption information.
- (c) Where a Retailer/DSP is required to obtain consent, such consent must be in verifiable form. The consent, then, may be written (in hard copy or in an electronic form), or oral, so long as there is a methodology in place to record such consent in verifiable form the fact that consent was given. The retailer will retain records of all consent in a form that verifies proof of consent in accordance with applicable laws, and will produce those records on request by ATCO Gas and Pipelines Ltd. or the Market Surveillance Administrator, or any authorized government agency.
- (d) The Retailer/DSP will maintain the confidentiality of, and will not use or disclose, the requested historical consumption information, except in accordance with all applicable laws.
- (e) ATCO Gas and Pipelines Ltd. makes no representation or warranty to the Retailer/DSP regarding the accuracy of any historical consumption information provided to the Retailer/DSP by ATCO Gas and Pipelines Ltd.
- (f) The Retailer/DSP shall indemnify and save harmless ATCO Gas and Pipelines Ltd., its directors, officers, agents, employees and representatives (collectively, the "Distribution Company Parties") from and against all claims, demands, proceedings, losses, damages, liabilities, costs and expenses (including all legal costs on a solicitor and his own client basis and other professional fees and disbursements, interest, penalties and amounts paid in settlement) suffered or incurred by the Distribution Company Parties, or any of them, or which may be brought against or suffered by the Distribution Company Parties, or any of them, or which the Distribution Company Parties, or any of them, may sustain, pay or incur as a result of or arising directly or indirectly out of or in connection with any breach by the Retailer/DSP of, or any inaccuracy of, any of these representations or warranties of the Retailer/DSP, except to the extent that such breach or inaccuracy was a result of or arose directly or indirectly out of or in connection with any negligence or willful misconduct of ATCO Gas and Pipelines Ltd..

The Retailer's address for notice is:		The Corporation's address for notice is:	
Retailer Name		ATCO Gas and Pipelines Ltd.	
Retailer Address		10035 105 Street Edmonton, Alberta, T5J 2V6	
Attention:		Customer Care & Billing	
Retailer Business ID(s):			

IN WITNESS WHEREOF the Parties have executed this Agreement as of the day first below mentioned.

Date: _____

[RETAILER NAME]

Per: _____

Name: _____

Title: _____

ATCO GAS AND PIPELINES LTD.

Per: _____

Name: _____

Title: _____

[RETAILER NAME]

Per: _____

Name: _____

Title: _____

ATCO GAS AND PIPELINES LTD.

Per: _____

Name: _____

Title: _____

APPENDIX F Authorization and Release Form

TO: ATCO Gas and Pipelines LTD ("the Company")
 10035 - 105 Street
 Edmonton, Alberta, T5J 2V6

(A) I/We _____, ("Customer") hereby requests and authorizes the Company to release requested Customer information related to the Site ID(s) or service location(s) to the Retailer/DSP listed below and acknowledges that such release may be subject to a fee in accordance with the Company's Terms and Conditions and Tariffs. **Customer further agrees to release and hold harmless ATCO Gas and Pipelines LTD from any claims, damages, or expenses resulting from the use of or reliance upon the Customer Information including any unauthorized use or disclosure by the Retailer/DSP.**

- If the Customer is a corporation, then the individual executing this authorization certifies that he/she has authority on behalf of the Customer to bind the Customer in this regard. (Please check if applicable)
- If an agent or consultant is acting on behalf of the Customer, then the agent or consultant certifies that he/she/it has the authority to bind the Customer in this regard. (Please check if applicable).

Billed consumption history to be provided for the most recent 12 months for the site customers noted below.

#	Customer Site ID	Service Location (LSD or Address)
1	_____	_____
2	_____	_____

(If additional site IDs required, please attach list electronically.)

(B) Retailer to Receive Customer Information: Preferred delivery method: E-mail Fax Mail

RETAILER	ADDRESS	CITY
_____	_____	_____
PROVINCE	CONTACT NAME	PHONE NUMBER
_____	_____	_____
FAX NUMBER	EMAIL	_____
_____	_____	_____
CUSTOMER NAME	AGENT/CONSULTANT (if applicable)	CUSTOMER ADDRESS
_____	_____	_____
CITY	PROVINCE	CONTACT NAME
_____	_____	_____
PHONE NUMBER	FAX NUMBER	EMAIL
_____	_____	_____

CUSTOMER OR AUTHORIZED SIGNATURE

DATE

APPENDIX G Letter of Credit

BANK FORM – LETTER OF CREDIT LETTER OF CREDIT NO.:

APPLICANT

Date of Issue: _____

AMOUNT: CAD \$ _____

**and 00/100
Canadian Dollars**

Expiry Date: _____

BENEFICIARY:

ATCO Gas and Pipelines Ltd.

ATCO Centre

10035-105 Street

Edmonton, AB T5J 2V6

AT THE REQUEST OF AND ON BEHALF OF THE APPLICANT WE HEREBY ESTABLISH IN YOUR FAVOUR OUR IRREVOCABLE LETTER OF CREDIT FOR A SUM NOT EXCEEDING THE ABOVE MENTIONED AGGREGATE AMOUNT.

THIS CREDIT SHALL BE AVAILABLE TO YOU BY YOUR SIGNED AND ENDORSED SIGHT DRAFT DRAWN ON **[NAME AND ADDRESS OF THE CANADIAN CHARTERED BANK]** WHEN SUPPORTED BY YOUR SIGNED CERTIFICATE STATING THAT THE AMOUNT DRAWN IS DUE AND PAYABLE BY THE APPLICANT PURSUANT TO ATCO GAS'S RETAILER TERMS AND CONDITIONS FOR GAS DISTRIBUTION SERVICE ("TERMS AND CONDITIONS"), AS AMENDED FROM TIME TO TIME.

IT IS UNDERSTOOD THIS CREDIT IS ISSUED FOR THE PAYMENT OF MONIES ONLY AND WE HEREBY AGREE THAT WE SHALL HONOUR YOUR DEMAND FOR PAYMENT WITHOUT ENQUIRING WHETHER YOU HAVE A RIGHT AS BETWEEN YOURSELVES AND THE APPLICANT TO MAKE SUCH DEMAND AND WITHOUT RECOGNIZING ANY CLAIM OF THE APPLICANT.

DRAFTS MUST INDICATE THAT THEY ARE DRAWN UNDER **[NAME AND ADDRESS OF CANADIAN CHARTERED BANK]** IRREVOCABLE LETTER OF CREDIT STATING NUMBER AND DATE.

DRAFTS DRAWN UNDER THIS CREDIT ARE TO BE ENDORSED HEREON.

WE HEREBY AGREE THAT DRAFTS DRAWN UNDER THIS CREDIT WILL BE DULY HONoured ON PRESENTATION PROVIDED THAT ALL TERMS AND CONDITIONS HAVE BEEN COMPLIED WITH AND THE DRAFTS ARE PRESENTED TO **[NAME AND ADDRESS OF CANADIAN CHARTERED BANK]** NOT LATER THAN THE ABOVE MENTIONED EXPIRY DATE. HOWEVER, IT IS A CONDITION OF THIS STANDBY LETTER OF CREDIT THAT IT SHALL BE DEEMED TO BE AUTOMATICALLY EXTENDED WITHOUT AMENDMENT FOR ONE YEAR FROM THE PRESENT OR ANY FUTURE EXPIRATION DATE HEREOF, UNLESS AT LEAST 30 DAYS PRIOR TO ANY SUCH EXPIRATION DATE, WE SHALL NOTIFY YOU IN WRITING BY REGISTERED MAIL OR COURIER THAT WE ELECT NOT TO CONSIDER THIS LETTER OF CREDIT RENEWED FOR SUCH FURTHER PERIOD.

EXCEPT SO FAR AS OTHERWISE EXPRESSLY STATED, THIS LETTER OF CREDIT IS SUBJECT TO THE "UNIFORM CUSTOMS AND PRACTICE FOR DOCUMENTARY CREDITS" (1993 REVISION) INTERNATIONAL CHAMBER OF COMMERCE (PUBLICATION NO. 500).

FOR [NAME OF BANK]

COUNTER SIGNATURE

AUTHORIZED SIGNATURE

APPENDIX H Guarantee

GUARANTEE

TO: ATCO Gas and Pipelines Ltd. (the "Company")

THIS GUARANTEE made as of the ____ day of _____, 200__.

In consideration of the Company now or hereafter entering into agreements and transactions (collectively the "Contracts") with _____ ("Customer"), a subsidiary of the undersigned _____ (the "Parent"), in connection with the provision by the Company of Distribution Access Service to serve the Customer's natural gas customers and other good and valuable consideration (the receipt and sufficiency of which is hereby acknowledged), Parent covenants and agrees with the Company as follows:

1. Parent hereby unconditionally and irrevocably guarantees to the Company, its successors and assigns, the prompt, timely and complete payment of all of the debts and liabilities, present or future, direct or indirect, absolute or contingent, matured or not, at any time owing by Customer to the Company pursuant to or arising from the Contracts (collectively, the "Obligations") plus any expenses (including all legal fees and disbursements) incurred by the Company in enforcing any of its rights under this guarantee and interest on unpaid amounts due under this guarantee calculated from the date on which those amounts were originally demanded until payment in full, both before and after judgment, at the rates and in the currency applicable to Customer's debts under the Contracts.
2. The liability of Parent hereunder shall be absolute and unconditional and, without limitation, shall not be affected by:
 - (a) any lack of validity or enforceability of the Contracts, any change in the time, manner or place of payment or in any other term of the Contracts, or the failure on the part of Customer to carry out any of its obligations under the Contracts;
 - (b) the bankruptcy, winding-up, liquidation, dissolution or insolvency of the Customer or the Company;
 - (c) any lack or limitation of power, incapacity or disability on the part of Customer or of the directors, partners or Agents thereof or any other irregularity, defect or informality on the part of Customer in its obligations to the Company; or
 - (d) any other circumstance which might otherwise constitute a defense available to, or a discharge of, Customer in respect of any or all of the obligations of Customer to the Company pursuant to the Contracts.
3. The liability of Parent hereunder shall not be released, discharged, limited or in any way affected by anything done, suffered or permitted by the Company in connection with any duties or liabilities of Customer to the Company or any security therefor including any loss of or in

respect of any security received by the Company from Customer or others. The Company may grant extensions of time or other indulgences, take and give up securities, accept compromises, grant releases and discharges and otherwise deal with Customer and other parties and securities as the Company may see fit, and may apply all moneys received from Customer or others, or from securities, upon such part of Customer's liability as it may think best, without prejudice to or in any way limiting or lessening the liability of Parent under this guarantee.

4. The Company shall not be bound or obligated to exhaust its recourse against Customer or other persons or any securities or collateral it may hold or take any other action before being entitled to demand payment or performance from Parent hereunder.
5. Parent shall not be entitled to claim or assert any defense available to Customer or claim or assert any set off, deduction, counterclaim or crossclaim against Customer in respect of any liability of Customer to Parent.
6. This guarantee shall be a continuing guarantee and shall be binding as a continuing obligation of Parent until all of the Obligations of Customer have been satisfied.
7. Should the Company receive from Parent a payment or payments in full or on account of the liability under this guarantee, Parent shall not be entitled to claim repayment against Customer until the Company's claims against Customer have been paid in full; and in case of liquidation, winding up or bankruptcy of Customer (whether voluntary or compulsory) or in the event that Customer shall make a bulk sale of any of its assets within the bulk transfer provisions of any applicable legislation or any composition with creditors or scheme of arrangement, the Company shall have the right to rank for its full claim and receive all dividends or other payments in respect thereof until its claim has been paid in full and Parent shall continue to be liable, up to the amount guaranteed, for any balance which may be owing to the Company by Customer.
8. No failure on the part of the Company to exercise, and no delay in exercising, any right hereunder shall operate as a waiver thereof, nor shall any single or partial exercise of any right hereunder preclude the other or further exercise thereof or the exercise of any right. The remedies herein provided are cumulative and not exclusive of any remedies provided by law. Any loss of or in respect of securities received by the Company from Customer or any other person, whether occasioned through the fault of the Company or otherwise, shall not limit or lessen the liability of Parent under this guarantee.
9. Parent shall make payment to the Company of the Obligations forthwith after written demand therefore is made to Parent. The Company shall be entitled to make demand upon Parent at any time upon default in payment by Customer of the Obligations and upon such default the Company may treat all such Obligations as due and may forthwith collect from Parent all amounts guaranteed hereunder.
10. Upon an event of default of the Customer in payment of the Obligations, all debts and liabilities, present and future, of Customer to Parent are hereby postponed to the Obligations of Customer to the Company, and all money received by Parent in respect thereof shall be received in trust for the Company and forthwith upon receipt shall be paid over to the Company, the whole without in any way lessening or limiting the liability of Parent hereunder and this postponement is independent of the guarantee and shall remain in full force and effect until payment in full to the Company of all obligations of Parent under this guarantee.

-
11. Unless a law requires otherwise, Parent will make all payments under this guarantee without deduction or withholding for any present or future taxes of any kind. If a law does so require, Parent will pay to the Company an additional amount as is necessary to ensure the Company receives the full amount the Company would have received if no deduction or withholding had been made.
 12. If any provision of this guarantee is determined to be invalid or unenforceable in whole or in part, such invalidity or unenforceability shall attach only to such provision and all other provisions hereof shall continue in full force and effect.
 13. Parent hereby waives notice of acceptance of this instrument.
 14. Parent represents and warrants that:
 - (a) at the date hereof, the Customer is a subsidiary of the Parent;
 - (b) Parent is duly incorporated under the laws of its jurisdiction of incorporation, is validly subsisting, has full power and has been duly authorized by all necessary corporate and other action to carry on its business and to enter into and perform its obligations under this guarantee;
 - (c) all necessary consents and authorities of any government agency or tribunal or other regulatory authority having jurisdiction required for Parent to enter into and perform its obligations under this guarantee have been obtained;
 - (d) this guarantee constitutes legal, valid and binding obligations enforceable against Parent in accordance with its terms except to the extent that such enforceability may be limited by the bankruptcy or insolvency of Parent or similar laws respecting the rights of creditors of Parent generally or by the availability of specific performance or other equitable remedies being in the discretion of the court; and
 - (e) the execution and delivery of, the performance of its obligations under and the compliance with the provisions of this guarantee by Parent will not:
 - (i) contravene any existing applicable law, statute, rule or regulation, nor any judgment, decree or permit to which Parent is subject;
 - (ii) conflict with or result in any breach of any of the terms of, or constitute a default under, any indenture, deed, mortgage, trust, agreement or other instrument material to the business, assets or financial condition of Parent and to which Parent is a party or is subject or by which it or any of its property is bound; or
 - (iii) result in the creation of any lien, charge or encumbrance upon any of the property or assets of Parent.
 15. Any change or changes in the name of Customer shall not affect or in any way limit or lessen the liability of Parent hereunder and this guarantee shall extend to the person, firm or corporation acquiring or from time to time carrying on the business of Customer.

-
16. Any account settled or stated by or between the Company and Customer shall be accepted by Parent as conclusive evidence that the balance or amount thereby appearing due by Customer to the Company is so due.
17. (a) All notices permitted or required to be given pursuant to this guarantee shall be in writing and may be delivered by hand, mailed by registered mail or otherwise or sent by telecopier.
- (b) All notices shall be deemed to be sufficiently given and received if:
- (i) personally served on the other party by delivery during the normal business hours of the recipient at the addresses set forth below, which notices shall be deemed to have been received when actually delivered;
- (ii) by telecopier (or by any other like method by which a written or recorded message may be sent) directed to the party on whom they are to be served at that party's fax number set forth below, which notice shall be deemed to have been received when actually received if received within the normal working hours of a business day, or, at the commencement of the next ensuing business day following transmission thereof; or
- (iii) mailed by registered mail or postage prepaid to the other party, which notice shall be deemed to have been received on the fifth business day following the date of mailing thereof, provided that in the event of an actual or threatened postal strike or other labour disruption that may affect the mail service, notices shall be deemed to be sufficiently given and received only when actually received.
- (c) A party may change its address for the receipt of notices at any time by giving notice thereof to the other parties.
- (d) Addresses for notices authorized or required to be given pursuant to this Agreement are as follows:

ATCO GAS AND PIPELINES LTD.
10035 -105 Street
Edmonton, Alberta
T5J 2V6
Attn: Account Financial Planning

18. This instrument is in addition and without prejudice to any securities of any kind (including without limitation guarantees and postponement agreements whether or not in the same form as this instrument) now or hereafter held by the Company.
19. Notwithstanding anything else stated in this guarantee, this guarantee constitutes the entire agreement between the Company and the Parent with respect to the guarantee's subject matter and cancels and supersedes any prior understandings and agreements between the Company and the Parent. There are no representations, warranties, terms, conditions, undertakings or collateral agreements, expressed, implied or statutory, between the parties other than as expressly stated in this guarantee.

-
20. This instrument shall be construed in accordance with the laws of the Province of Alberta, and Parent agrees that any legal suit, action or proceeding arising out of or relating to this instrument may be instituted in the courts of such province or territory, and Parent hereby accepts and irrevocably submits to the jurisdiction of the said courts and acknowledges their competence and agrees to be bound by any judgment thereof, provided that nothing herein shall limit the Company's right to bring proceedings against Parent elsewhere.
21. This instrument shall extend to and enure to the benefit of the successors and assigns of the Company, and shall be binding upon Parent and the successors and assigns of Parent.

[PARENT]

Per: _____

c/s

Per: _____

APPENDIX I Confidentiality Agreement

[Retailer/DSP Name]
Address

Attention:

Re: Distribution Access Services
Retailer Financial Information

During the course of our business dealings with your Company ATCO Gas and Pipelines Ltd. (ATCO Gas) must obtain, for credit evaluation purposes, detailed financial information regarding your Company and its business activities. This financial information will include, but not necessarily be limited to, with your prior authorization: (a) your financial statements and other pertinent financial information and (b) independent confirmation from your bank(s) and other financial institution(s) regarding your financial circumstances.

ATCO Gas recognizes that some or all of this information may be confidential and, to the extent that it is, we hereby undertake to maintain such information in confidence and will not disclose it to any person or entity other than our employees, officers, directors, advisors and Agents who have a need to know and who have been advised of the confidentiality of the information and have agreed to be bound by this undertaking.

This undertaking will not apply to any confidential information which: (a) was in the public domain at the time of disclosure to us; (b) thereafter passes into the public domain by acts other than the acts of or caused by ATCO Gas; (c) is thereafter disclosed to ATCO Gas by third parties provided that ATCO Gas does not know, or has no reasonable basis to know, that the information was received or disclosed unlawfully; or (d) is required by law (including any applicable court order, government or regulatory authority order, rule, regulation or procedure) to be disclosed.

ATCO Gas agrees that monetary damages may be an insufficient remedy for any actual or anticipatory breach of this undertaking and therefore, in addition to any other remedy which may be available to you, injunctive relief is an appropriate remedy to prevent the unwarranted disclosure of confidential information. However, in no event shall you be entitled to indirect, consequential punitive or exemplary damages from ATCO Gas.

This agreement and undertaking shall be governed by the laws of the Province of Alberta and ATCO Gas agrees to attorn to the jurisdiction of the Courts of the Province of Alberta.

Yours truly,

Vice President

Agreed to by both parties:

[Retailer]

ATCO Gas and Pipelines Ltd.

Per: _____

Per: _____

APPENDIX J Agency Appointment Agreement

TO: ATCO Gas and Pipelines Ltd. (“the Company”)
10035-105 Street
Edmonton, Alberta T5J 2V6

I/We _____ (“the Retailer/DSP or Self-Retailer”) hereby appoint
_____ (“the Agent”) as the Retailer or Self-Retailer’s sole and
exclusive Agent to:

- (a) request and receive the Retailer’s/DSP’S Customer Usage Information (“Customer Information”) including, without limitation interval, meter data, financial billing data, site configuration data, and site and service information, from the Company on behalf of the Retailer; and
- (b) deal with the Company on behalf of the Retailer/DSP with respect to all Distribution Access Services provided by the Company to the Retailer including, but not limited to, metering, meter reading, billing and invoicing for Distribution Access Service at the Self-Retailer’s site;

(Collectively referred to as “Arrangements”)

The Agent agrees to enter into such further agreements with the Company as the Company deems necessary to permit the Company to deal with the Agent on behalf of the Retailer.

The Retailer/DSP acknowledges and agrees to be bound by the terms and conditions of any agreement between the Agent and the Company with respect to the Customer Information and/or Distribution Access Service. The Retailer/DSP further acknowledges, agrees to, and hereby does, ratify and confirm all actions taken by the Agent on the Self-Retailer’s behalf.

The Agent acknowledges and agrees to act in accordance with the terms and conditions of any agreement between the Retailer/DSP and the Company with respect to the Customer Information and/or Distribution Access Services including, but not limited to the Company’s Retailer Terms and Conditions for Gas Distribution Service and the Company’s Customer Terms and Conditions for Gas Distribution Service, as they are approved by the AUC, from time to time (collectively, “Terms and Conditions”).

The Company may rely exclusively upon, and deal exclusively with, the Agent with respect to all Arrangements on the Self-Retailer’s behalf as if the Arrangements had been made by the Self-Retailer.

The Retailer/DSP confirms and agrees that:

- (a) the Retailer is responsible for the payment of all amounts pursuant to the Terms and Conditions;
- (b) the Retailer/DSP shall make all payments required pursuant to the Terms and Conditions and pursuant to any Arrangements made by the Agent on behalf of the Self-Retailer, when due.

The Retailer/DSP and Agent, jointly and severally covenant to indemnify and save harmless the Company, and its directors, officers, employees, Agents and representatives (“Indemnified Parties”) from any and all damages, costs, expenses (including, but not limited to, attorney fees on a solicitor and own client basis), losses or claims incurred by such Indemnified Parties directly or indirectly resulting or arising from the Company’s reliance upon the Agent’s authority hereunder, and/or from the acts or omissions of the Agent in exercising its authority hereunder.

This Appointment and the Agent’s authority to act hereunder shall be and remain in full force and effect until the Retailer/DSP notifies ATCO Gas Ltd. in writing that the Retailer/DSP has revoked its appointment of the Agent as its Agent.

RETAILER/DSP NAME

DATE

Accepted by:

AGENT

DATE